

# Thule Rapid System Kit 1592

# > Instructions

**VOLKSWAGEN Passat**, 4-dr Sedan, 05-09, 10- / \*06-

\*North America

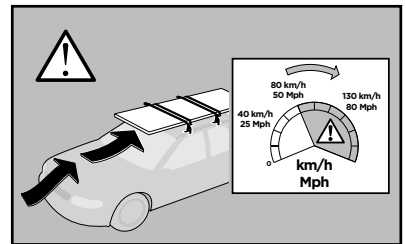
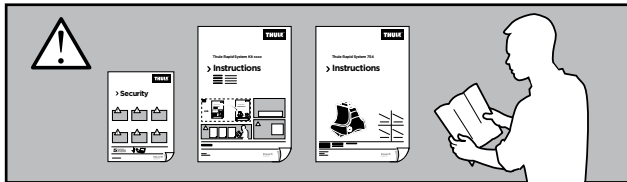
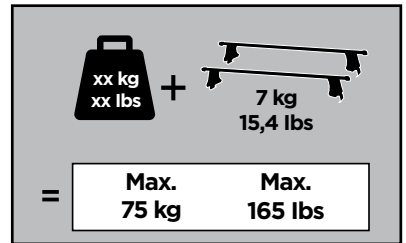
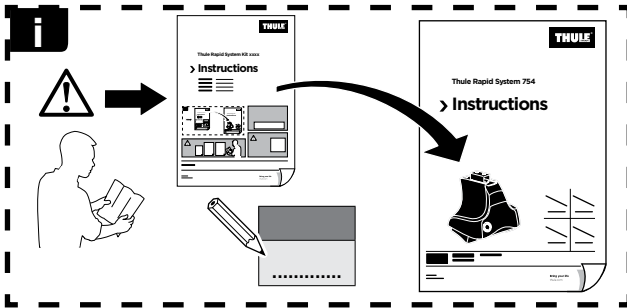

ISO 11154-E



163 x2

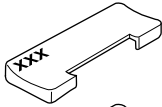

164 x2

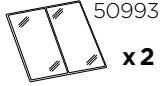
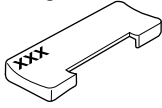

725 x1

726 x1

1094 x1

1095 x1



x1

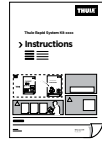

x1

1

	X (scale)	X (mm)	X (inch)
<b>VOLKSWAGEN Passat, 4-dr Sedan, 05-09, 10- / *06-</b>	<b>40,5</b>	<b>1056</b>	<b>41 5/8</b>

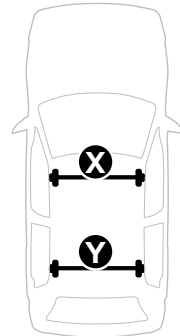
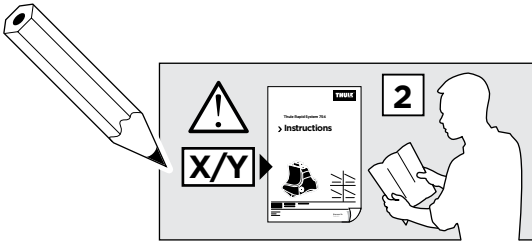

	Y (scale)	Y (mm)	Y (inch)
<b>VOLKSWAGEN Passat, 4-dr Sedan, 05-09, 10- / *06-</b>	<b>39</b>	<b>1041</b>	<b>41</b>

**2**

**VOLKSWAGEN Passat**, 4-dr Sedan, 05-09, 10- / \*06-

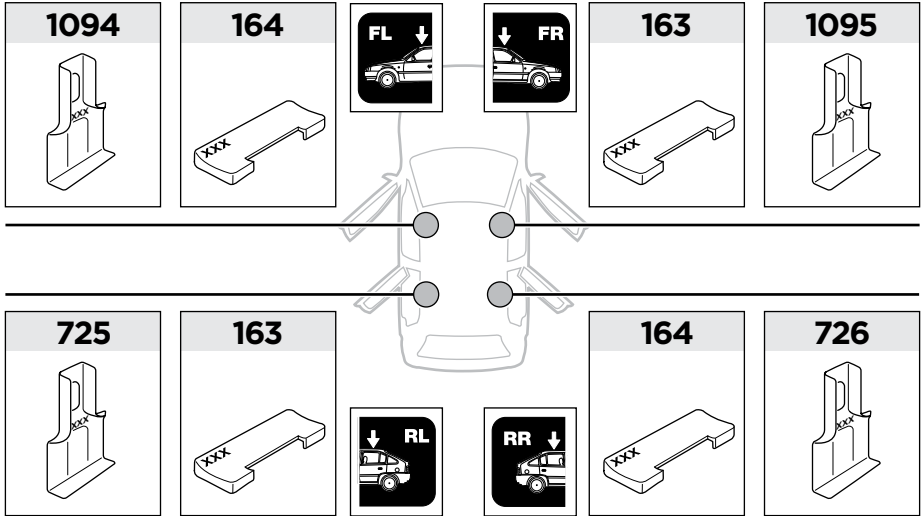

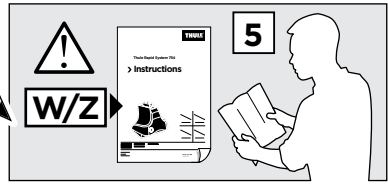
**3**

	W (mm)	Z (mm)	W (inch)	Z (inch)
<b>VOLKSWAGEN Passat</b> , 4-dr Sedan, 05-09, 10- / *06-	<b>270</b>	<b>775</b>	<b>10 <sup>5</sup>/<sub>8</sub></b>	<b>30 <sup>1</sup>/<sub>2</sub></b>

