

A G%, 1 (

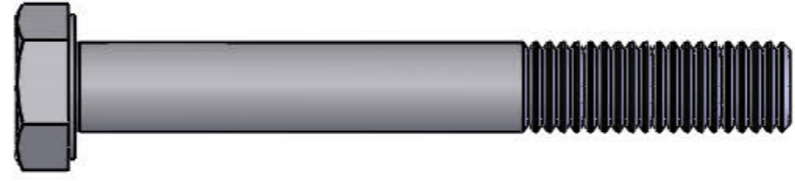

9LH\$-!\$\$ (1 \*



: 6\$%&fA , 1'\*) 71 %&

fP%7

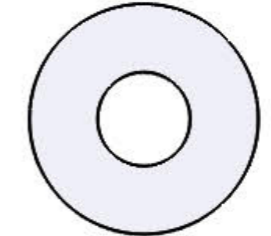

: K \$\$&fA , 71 ' \$



: B \$\$\* fA , 71 %&

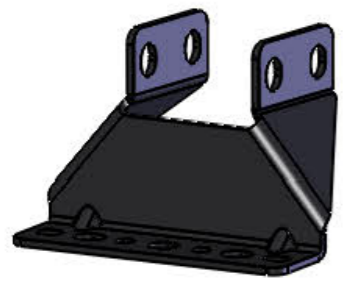

A G%+\*1 &



DG\$, -1 %



: G\$\*\* fA , 1'(\$71 &

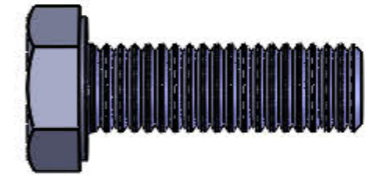

: G\$\* &fA , 1'&) 71 (

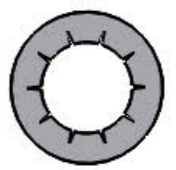

: K \$\$- fA , 71 \*



DG\$- \*1 &



DG\$- \$1 %

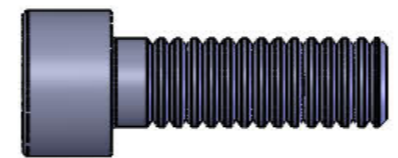

: G\$) - fA , 1'&) 71 %\*

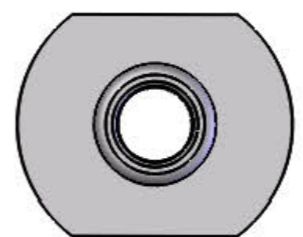

: B \$&' fA , 71 %\*



DG\$)' 1 &

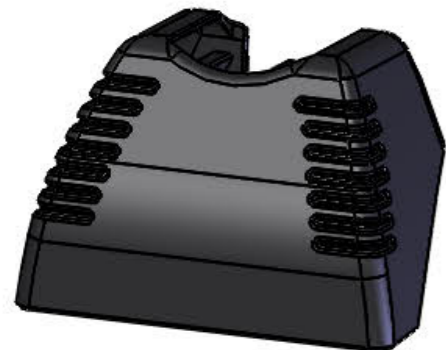

DG\$-) 1 (



DG\$(+1 (

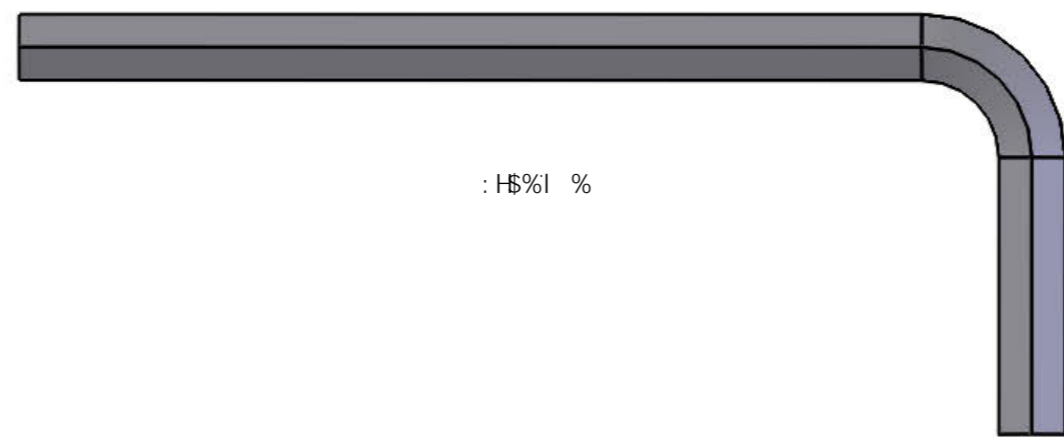

: H\$%l %

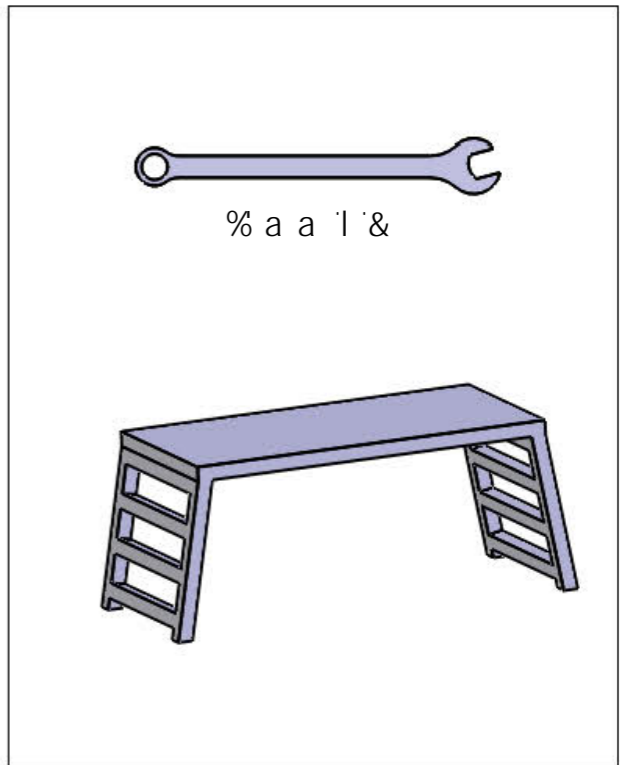

% a a 'l' &

