

<h1>EU/R 604</h1>  <p>46kg + xx kg = Max. 200kg</p>	<p>MASTER/MOVANO/NV400 2010- L1 H2</p>  <p>3182 mm 5048 mm 2300 mm / 2500 mm</p>	 <p>BW 36 RQ</p>
--	---	--

<h1>EU/R 605</h1>  <p>50kg + xx kg = Max. 200kg</p>	<p>MASTER/MOVANO/NV400 2010- L2 H2</p>  <p>3683 mm 5548 mm 2500 mm</p>	 <p>BW 38 RQ</p>
---	--	---

--	--	--

--	--	--

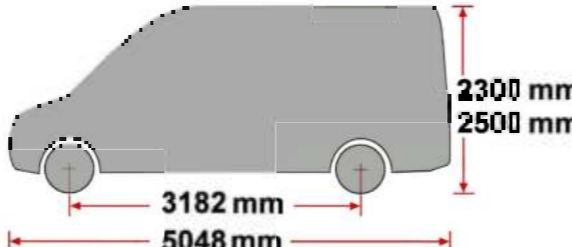
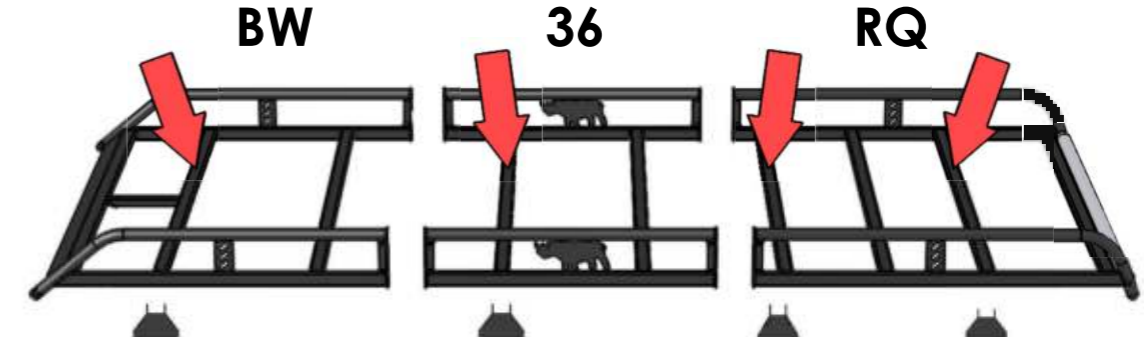
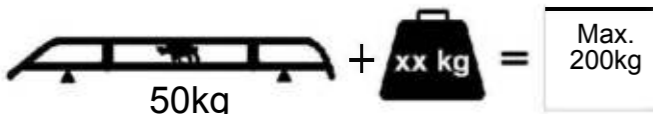
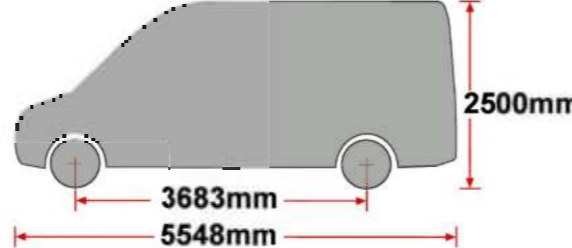
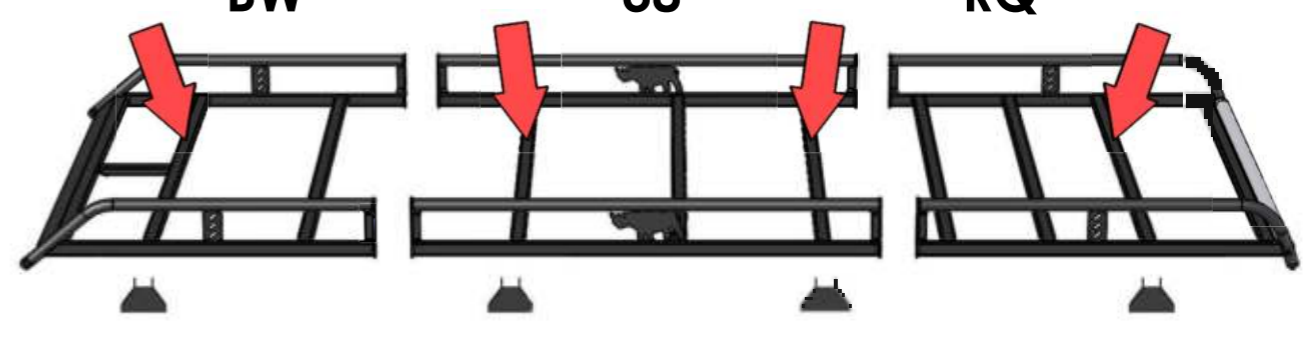
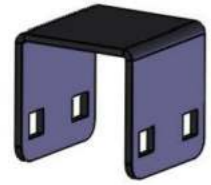

MS161 x 8

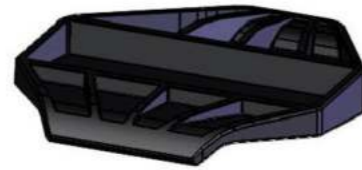

PS094 x 8



MS176 x 8



PS083 x 8

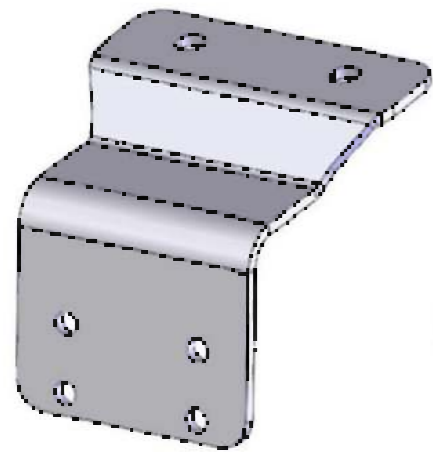

MS267 x 8



(SA013) x 4



PS133-150 x 2



PS082 x 8



PS064 x 2

(1:1)

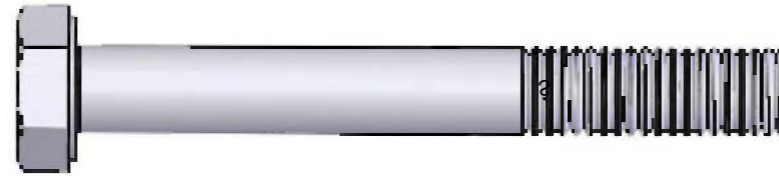

FB003 (M8 X 65) x 16

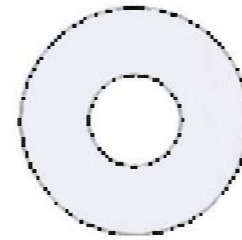
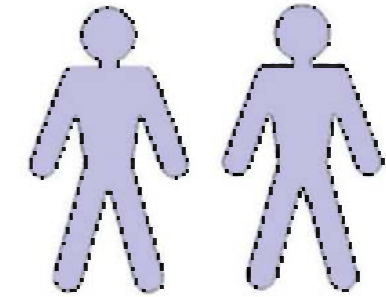

FW002 (M8) x 64

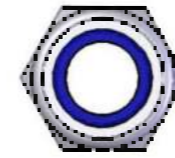

FN006 (M8) x 40



13mm x 2



FB006 (M8 X 30) x 16



FS001 (M6 x 20) x 16



10mm x 1

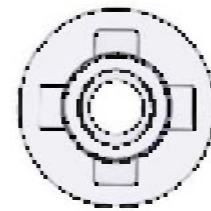

FN003 (M6) x 16

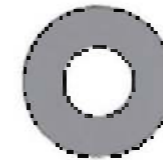

FW001 (M6) x 16

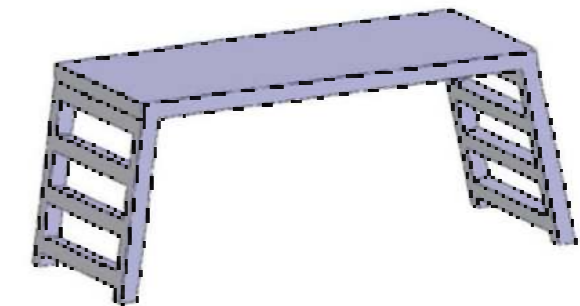

FS015 (M8 X 25) x 8

