

MS201 x 6



MS168 x 4



MS176 x 2



29201113 x 2



PS023 x 4

(1:1)

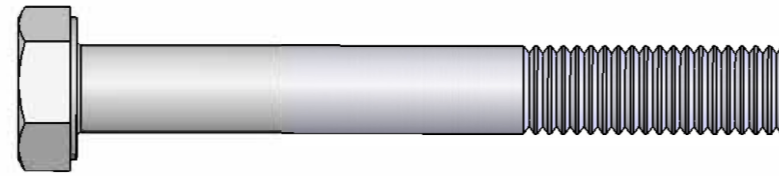

FB003 (M8 x 65) x 12

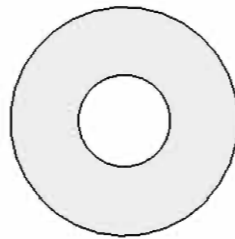

FW002 (M8) x 30



FN006 (M8) x 18

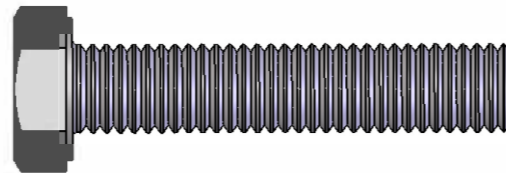

FS035 (M8 x 40) x 2

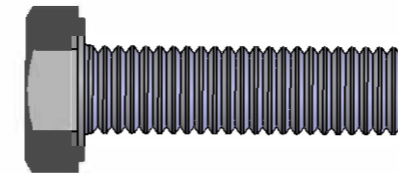

FB006 (M8 x 30) x 4

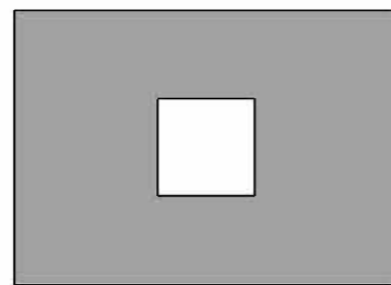

MS209 x 6

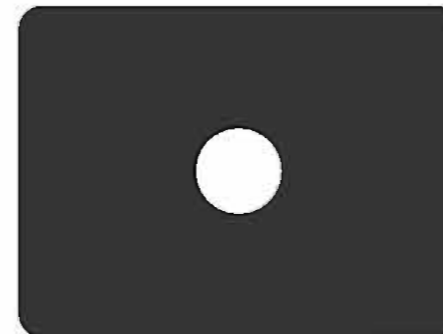

PS020 x 6

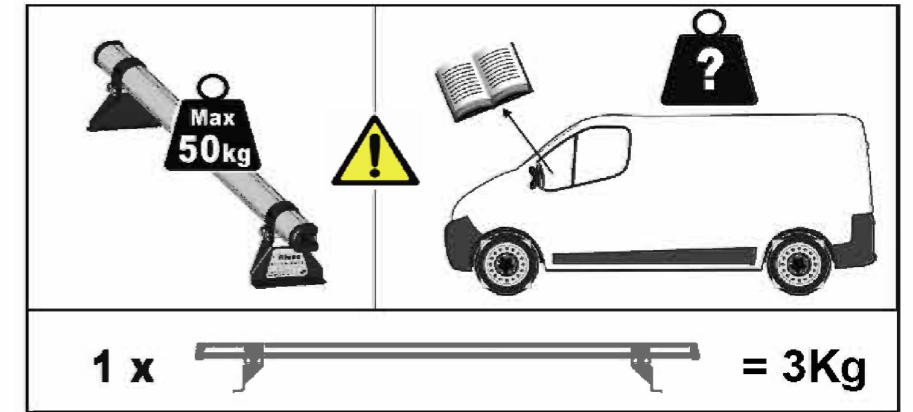

1 x [Delta Bar] = 3Kg

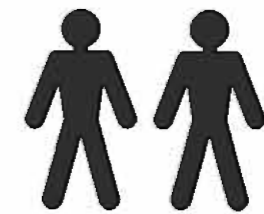

13mm x 2

