



## Thule XT Kit 3175

# > Instructions

**CITROËN Berlingo**, 4-dr Van, 19-  
**OPEL Combo**, 4-dr Van, 19-  
**OPEL Combo Life**, 5-dr MPV, 19-  
**PEUGEOT Partner**, 4-dr Van, 19-  
**VAUXHALL Combo**, 4-dr Van, 19-  
**VAUXHALL Combo Life**, 5-dr MPV, 19-

This kit is only for vehicles with fixpoint mounting.

The diagram illustrates the kit's contents and usage. On the left, it shows two 'FootPack' instruction manuals (751 and 753) and a 'Security' manual. In the center, two weight limit calculations are shown:  $xx \text{ kg} / xx \text{ lbs} + 6 \text{ kg} / 13 \text{ lbs} = \text{Max. } 100 \text{ kg} / 220 \text{ lbs}$  and  $xx \text{ kg} / xx \text{ lbs} + 9 \text{ kg} / 20 \text{ lbs} = \text{Max. } 150 \text{ kg} / 330 \text{ lbs}$ . On the right, two panels show the installation of the rack on a vehicle roof and a speedometer diagram with a warning triangle. The speedometer diagram indicates a maximum speed of 80 km/h (50 Mph) and 130 km/h (80 Mph), with a lower limit of 40 km/h (25 Mph) for a specific condition.

ISO 11154-E

183175

C.20190902  
509-3175-03

Bring your life  
thule.com

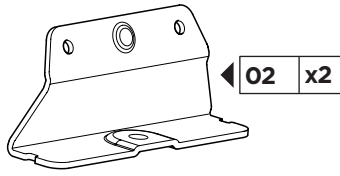
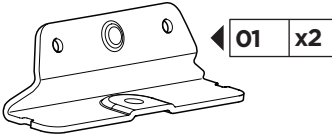

51342

20 mm  x4

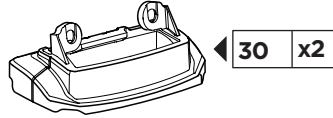
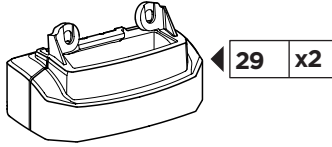

50229

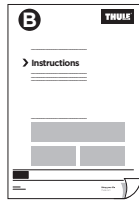
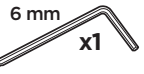

x1

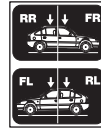

x1



751  
FootPack



753  
FootPack

**A**

12 mm  x8

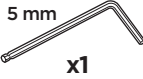

**A**

16 mm  x8

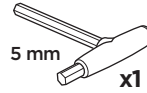

**1**

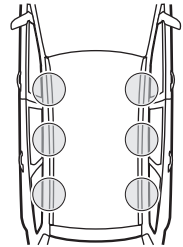
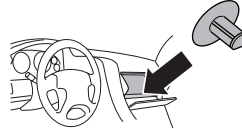
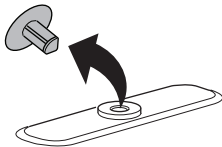

2

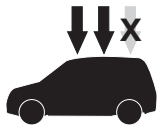
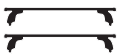

# 753

FootPack

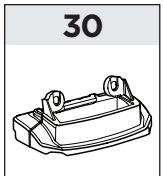
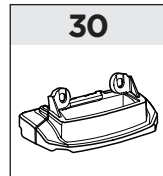
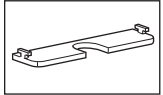
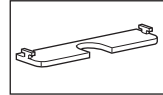
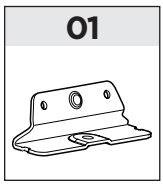
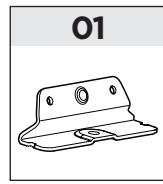
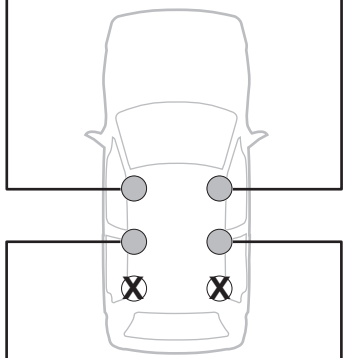
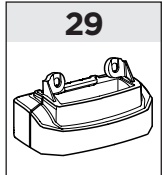
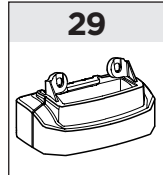
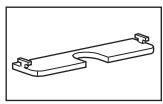
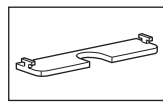
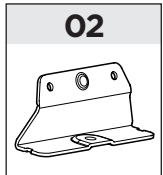
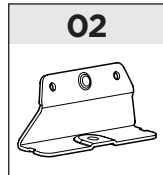

2

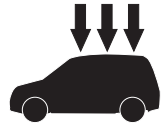

### 751 FootPack

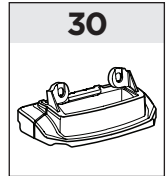
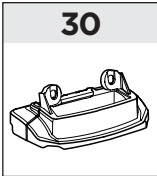
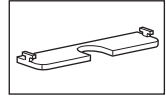
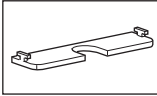
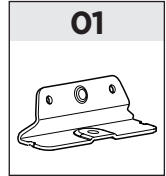
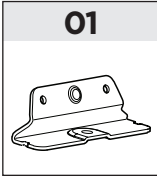

### 753 FootPack

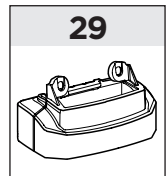
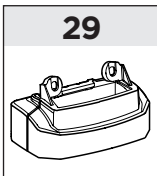
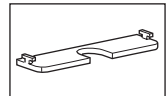
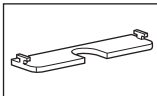
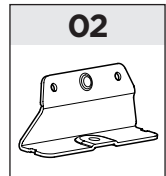
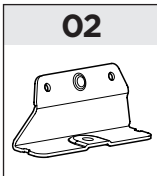

# 3 753 FootPack

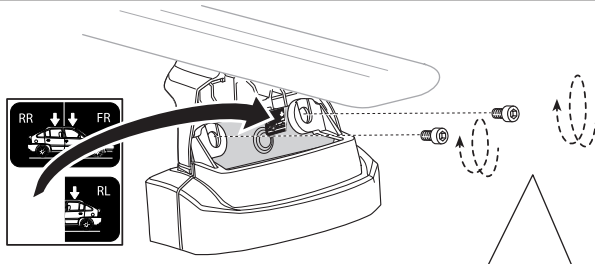
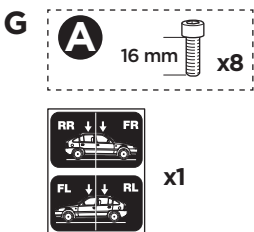
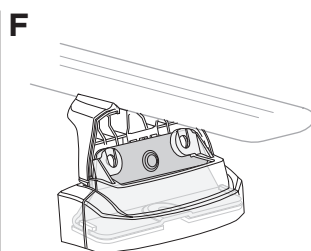
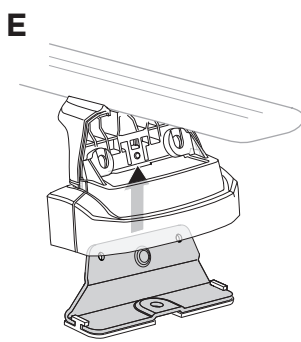
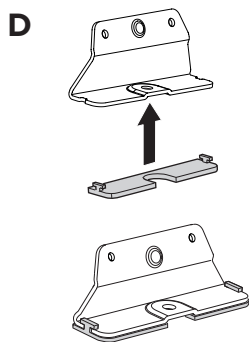
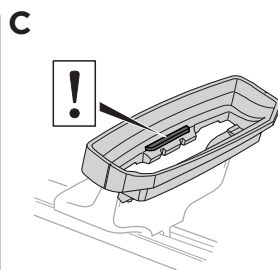
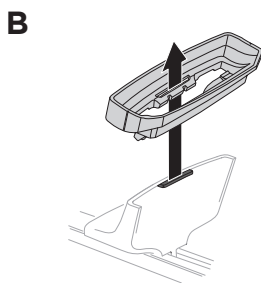
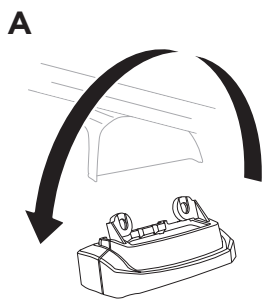

**EN** Only a few turns  
**DE** Nur wenige Umdrehungen  
**FR** Quelques tours uniquement  
**NL** Slechts enkele slagen  
**IT** Solo qualche giro  
**ES** Sólo algunas vueltas  
**PT** Noções básicas  
**SV** Endast några varv  
**DK** Kun nogle få omgange  
**NE** Bare noen få omdreinger  
**FI** Vain muutama kierros

**ET** Ainult mõni pööre  
**LV** Tikai dažī apgriezieni  
**LT** Tik keli pasukimai  
**PL** Wystarczy kilka obrotów  
**RU** Только несколько оборотов  
**UK** Лише декілька обертів  
**BG** Само няколко завъртания  
**CS** Pouze několik otáček  
**SK** Len niekoľko otáčok  
**SL** Le nekaj obratov  
**HR/BIH** Samo nekoliko okreta

**RO** Doar câteva rotiri  
**HU** Csak néhány fordítás  
**EL** Μόνο λίγες περιστροφές  
**TR** Yalnızca birkaç tur  
**ZH** 仅几圈  
**JA** 2 ~ 3 回転のみ  
**KO** 몇 번만 돌리면 됨  
**TH** เพียงสองสามรอบ

AR بعض دورات فقط  
 HE רק מספר סיבובים

3



751  
FootPack

A

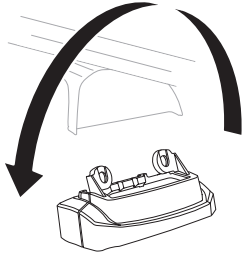

B

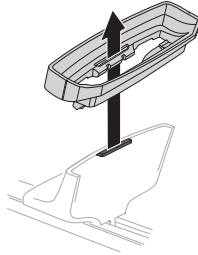

C

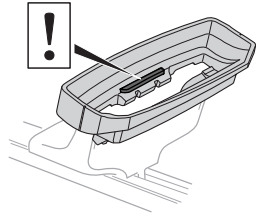

D

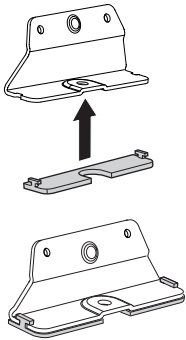

E

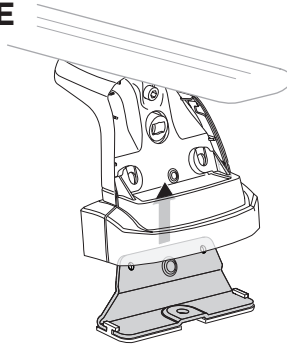

F

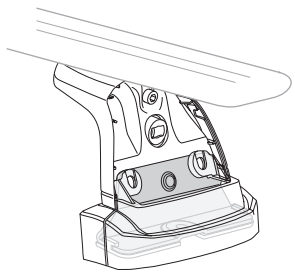

G

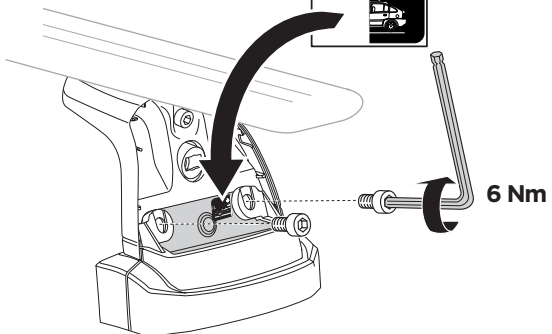
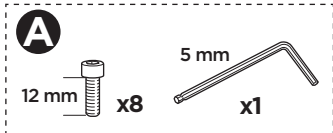

4

**753**  
FootPack

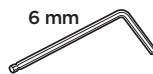
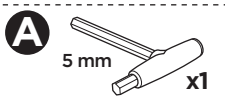

**A**

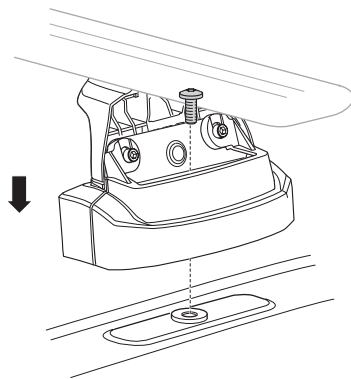

**B**

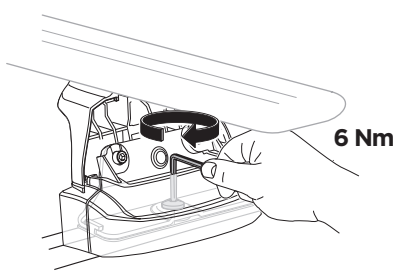
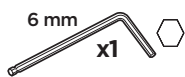

**C**

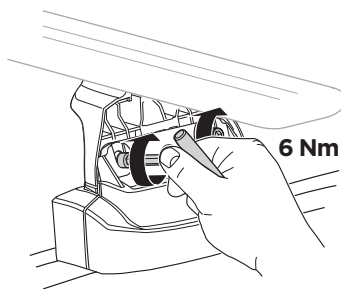
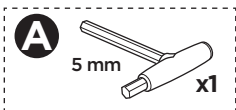

4



751  
FootPack

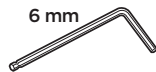
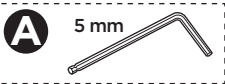

A

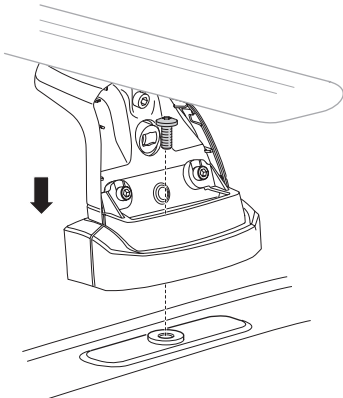

B

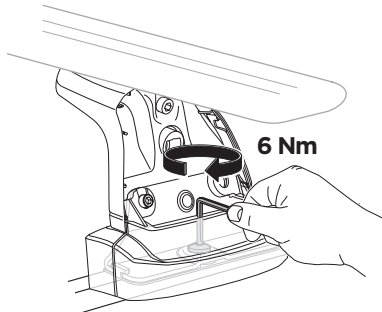
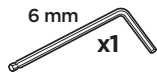

C

