

1

Kit 145169

NISSAN Micra (K13), 5-dr Hatchback, 10-16
 NISSAN March (K13), 5-dr Hatchback, 10-16



ISO 11154-E

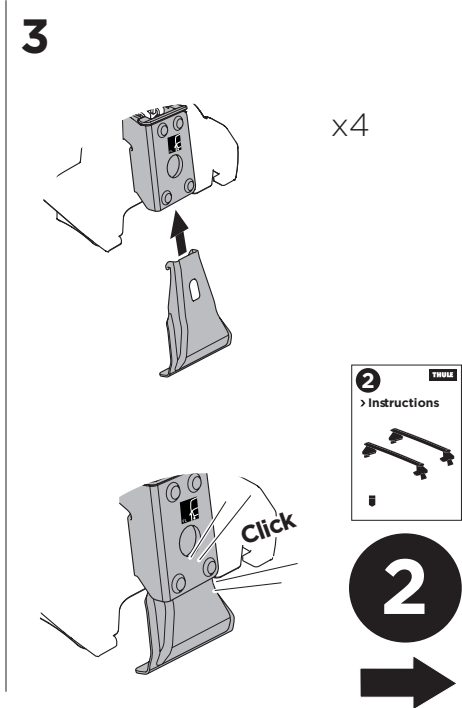
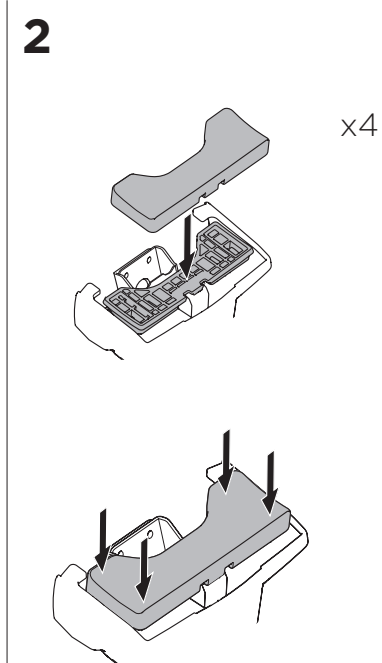
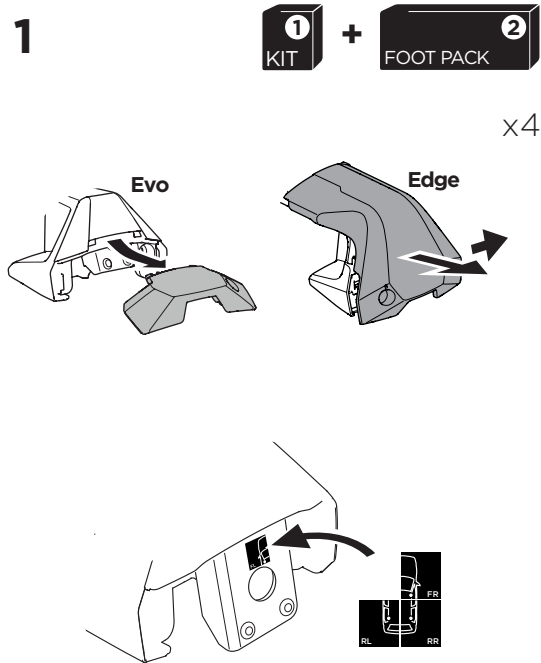
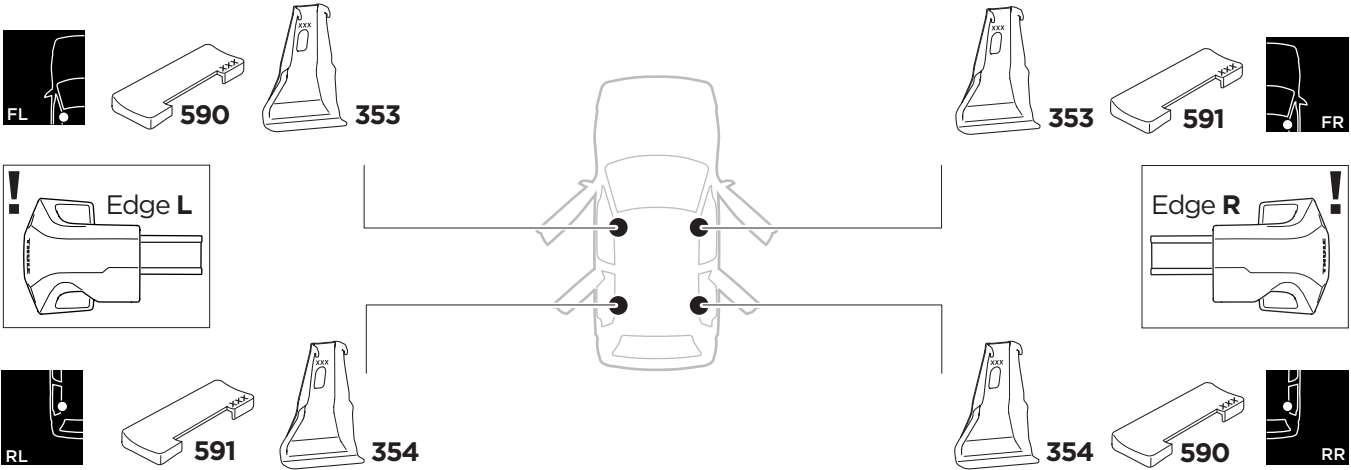
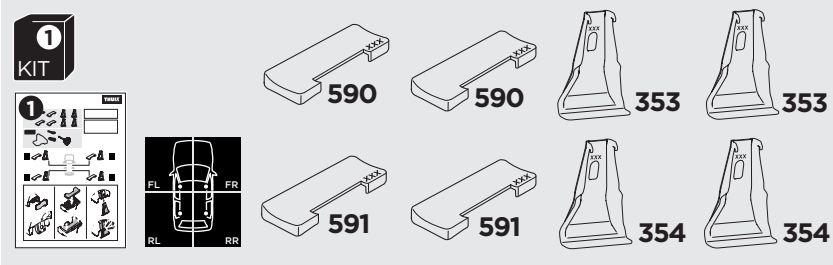



THULE WingBar Evo	THULE WingBar Edge	THULE WingBar	THULE SquareBar	Evo X (scale)	Edge X (scale)
NISSAN Micra (K13), 5-dr Hatchback, 10-16				23	0
NISSAN March (K13), 5-dr Hatchback, 10-16				23	0

THULE ProBar	THULE SlideBar	X (mm/inch)
NISSAN Micra (K13), 5-dr Hatchback, 10-16		881 mm / 34 5/8"
NISSAN March (K13), 5-dr Hatchback, 10-16		881 mm / 34 5/8"

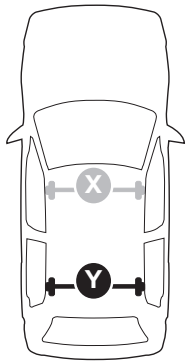

THULE WingBar Evo	THULE WingBar Edge	THULE WingBar	THULE SquareBar	Evo Y (scale)	Edge Y (scale)
NISSAN Micra (K13), 5-dr Hatchback, 10-16				20	C
NISSAN March (K13), 5-dr Hatchback, 10-16				20	C

THULE ProBar	THULE SlideBar	Y (mm/inch)
NISSAN Micra (K13), 5-dr Hatchback, 10-16		851 mm / 33 1/2"
NISSAN March (K13), 5-dr Hatchback, 10-16		851 mm / 33 1/2"

	W (mm/inch)	Z (mm/inch)
NISSAN Micra (K13), 5-dr Hatchback, 10-16	650 mm / 25 5/8"	295 mm / 11 5/8"
NISSAN March (K13), 5-dr Hatchback, 10-16	650 mm / 25 5/8"	295 mm / 11 5/8"

