

**Fit tips!**

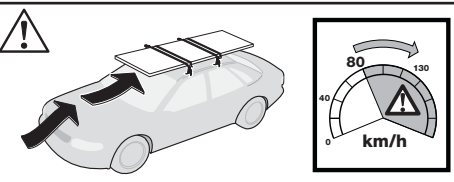

**838**

<b>GB</b> Accessories	<b>SK</b> Príslušenstvo
<b>D</b> Zubehör	<b>SLO</b> Dodatki
<b>F</b> Accessoires	<b>HR</b> Dodaci
<b>NL</b> Accessoires	<b>HU</b> Tartozékok
<b>I</b> Accessori	<b>GR</b> Παρελκόμενα
<b>E</b> Accesorios	<b>TR</b> Aksesuarlar
<b>PT</b> Acessórios	<b>中文</b> 附件
<b>S</b> Tillbehör	<b>日本語</b> 付属品
<b>FIN</b> Lisävarusteet	<b>한국어</b> 액세서리
<b>EST</b> Lisavarustus	<b>ไทย</b> อุปกรณ์เสริม
<b>LAT</b> Piederumi	
<b>LIT</b> Priedai	
<b>PL</b> Akcesoria	
<b>RU</b> Аксессуары	
<b>CZ</b> Dopřívky	

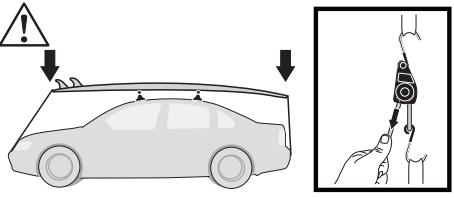
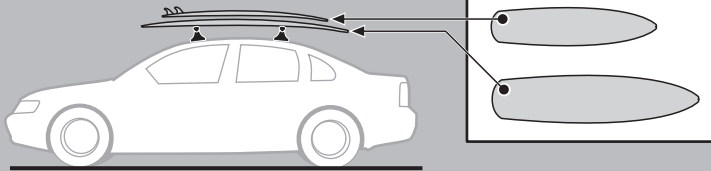
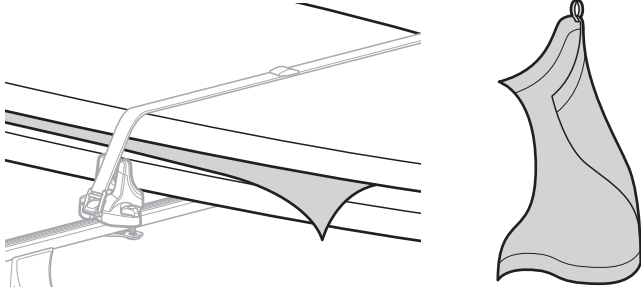
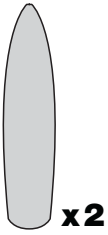

**THULE**<sup>®</sup>  
SWEDEN

- GB** Fitting instructions
- D** Montageanleitung
- F** Instructions de montage
- NL** Montage-instructies
- I** Istruzioni per il montaggio
- E** Instrucciones de montaje
- PT** Instruções de Montagem
- S** Monteringsanvisning
- FIN** Asennusohje
- EST** Paigaldusjuhend
- LAT** Stiprināšanas instrukcija
- LIT** Pritvirtinimo instrukcijos
- PL** Instrukcja montażu
- RU** Инструкции по установке
- CZ** Návod na montáž

- SK** Návod na montáž
- SLO** Navodila za pritrjevanje
- HR** Uputa za sastavljanje
- HU** A felszerelés módja
- GR** Οδηγίες συναρμολόγησης
- TR** Montaj talimatları
- 中文** 安装说明
- 日本語** 取扱(取付)説明書
- 한국어** 장착 지침
- ไทย** คำแนะนำการติดตั้ง

**832**  
832000



**Follow me...**

**THULE**<sup>®</sup>  
SWEDEN

Box 69, 330 33 Hillerstorp, SWEDEN  
www.thule.com

20100520•4DF/501-7008-05

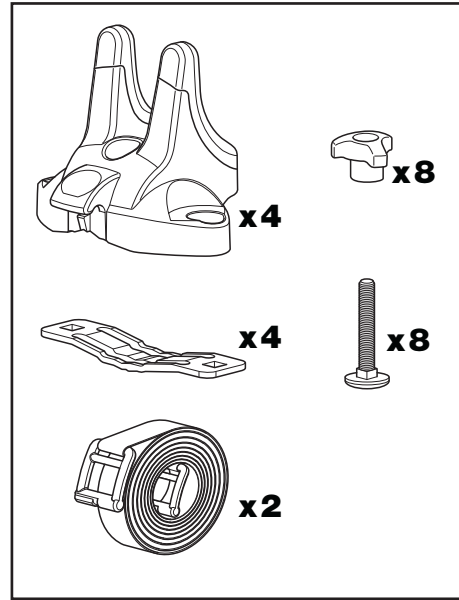
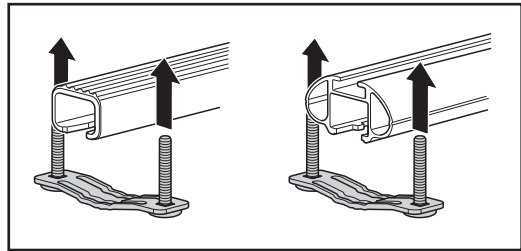
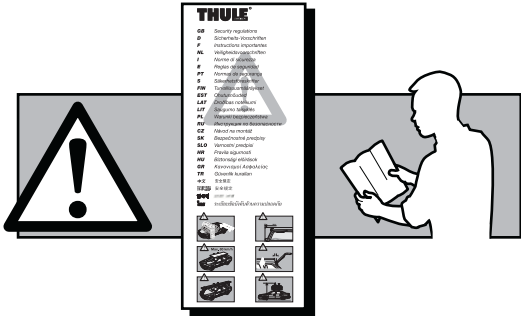

**1**

\* GB Only a few turns  
 \* D Nur wenige Umdrehungen  
 \* F Quelques tours uniquement  
 \* NL Slechts enkele slagen  
 \* I Solo qualche giro  
 \* E Sólo algunas vueltas  
 \* PT Noções básicas  
 \* S Endast några varv  
 \* FIN Vain muutama kierros  
 \* EST Ainult mõni pööre  
 \* LAT Tikai daži apgrīzieni  
 \* LIT Tik keli pasukimai  
 \* PL Wystarczy kilka obrotów  
 \* RU Достаточно нескольких оборотов  
 \* CZ Pouze několik otáček  
 \* SK Len niekoľko otáčok  
 \* SLO Le nekaj obratov  
 \* HR Samo nekoliko okreta  
 \* HU Csak néhány fordítás  
 \* GR Μόνο μερικές στροφές  
 \* TR Yalnız birkaç kez çevirme  
 \* 中文 只有几个转向  
 \* 한국어 두 세션만  
 \* 日本語 数回転のみ  
 \* ไทย หมุนเพียงไม่กี่รอบ

**2**

**Min 610 mm**

**3 Nm**

**3**