



Thule XT Kit 3099

> Instructions

VOLKSWAGEN Saveiro, 2-dr Pickup, 10-

This kit is only for vehicles with fixpoint mounting.

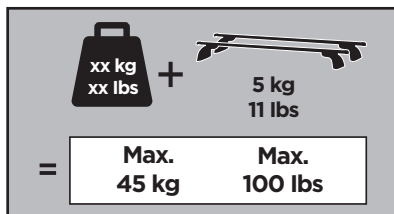

ISO 11154-E

183099

C.20130604
509-3099-01

Bring your life
thule.com

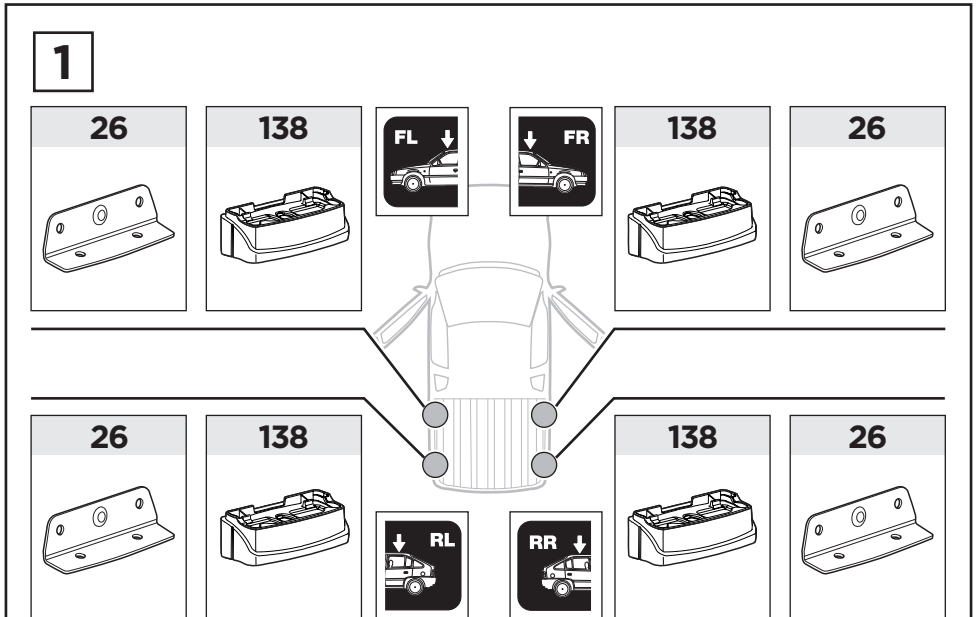
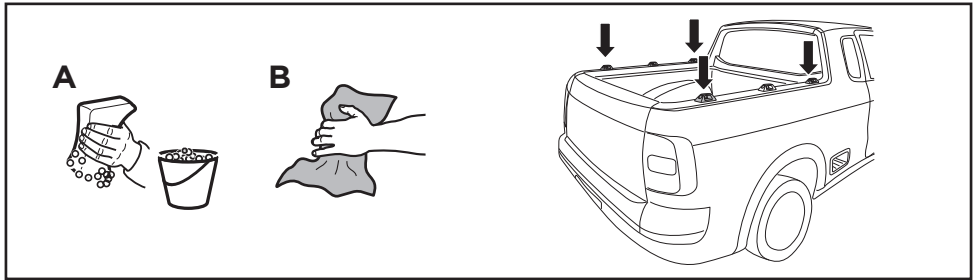
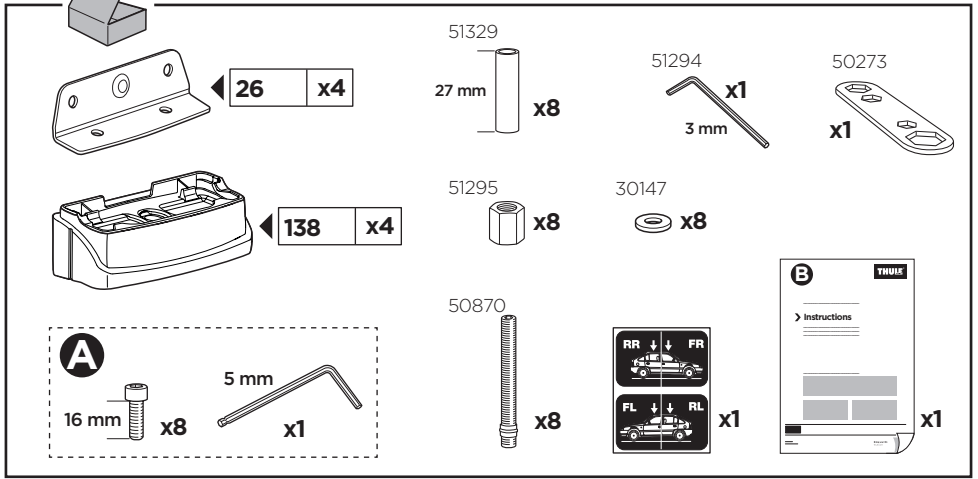

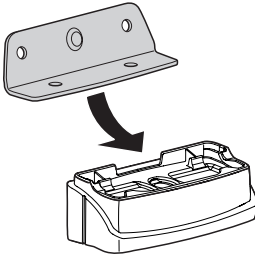
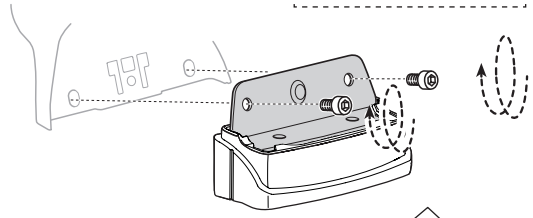
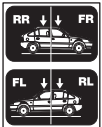
2**A****B**
A 16 mm  x8
**EN** Only a few turns**DE** Nur wenige Umdrehungen**FR** Quelques tours uniquement**NL** Slechts enkele slagen**IT** Solo qualche giro**ES** Sólo algunas vueltas**PT** Noções básicas**SV** Endast några varv**DK** Kun nogle få omgange**NE** Bare noen få omdreininger**FI** Vain muutama kierros**ET** Ainult mõni pööre**LV** Tikai dažī apgriezieni**LT** Tik keli pasukimai**PL** Wystarczy kilka obrotów**RU** Только несколько оборотов**UK** Лише декілька обертів**BG** Само няколко завъртания**CS** Pouze několik otáček**SK** Len niekoľko otáčok**SL** Le nekaj obratov**HR/BiH** Samo nekoliko okreta**RO** Doar câteva rotiri**HU** Csak néhány fordítás**EL** Μόνο λίγες περιστροφές**TR** Yalnızca birkaç turبعض دورات فقط **AR**רק מספר סיבובים **HE****ZH** 仅几圈**JA** 2～3回転のみ**KO** 몇 번만 돌리면 됨**TH** เพียงสองสามรอบ**3**

x1

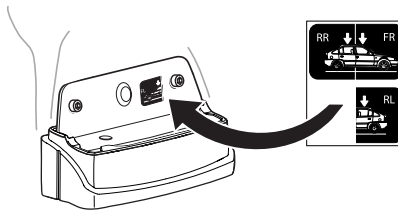
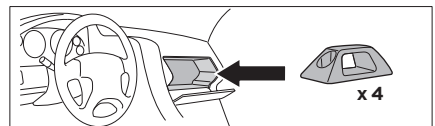
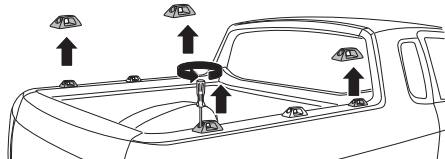
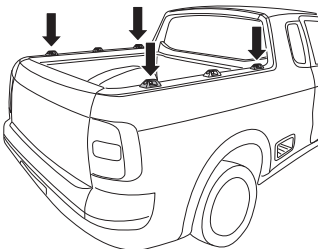
**4**

x4

5

x8



x8



x8



x8

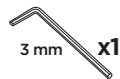

3 mm x1

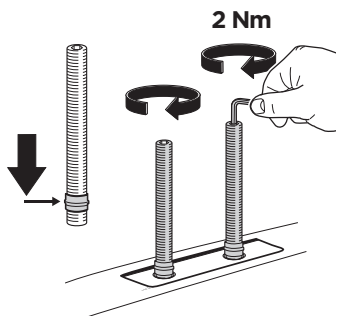
B

2 Nm

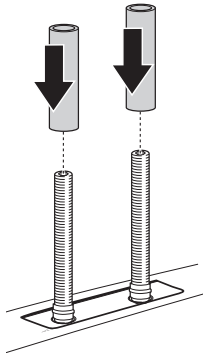
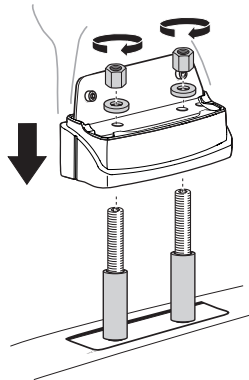
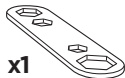
C**D****6****A**

x1

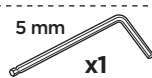
B**A**

5 mm x1

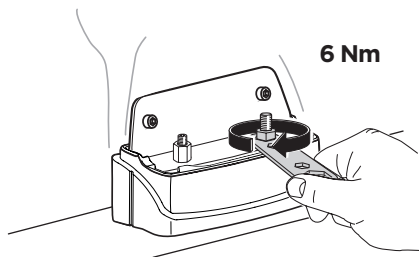

6 Nm

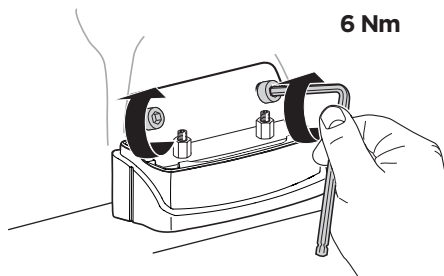

6 Nm

