



Thule XT Kit 3071

> Instructions

MITSUBISHI Lancer, 4-dr Sedan, 08-

MITSUBISHI Lancer, 5-dr Hatchback, 08- / *10-

MITSUBISHI Lancer EVO X, 4-dr Sedan, 08-

*North America

This kit is only for vehicles with fixpoint mounting.

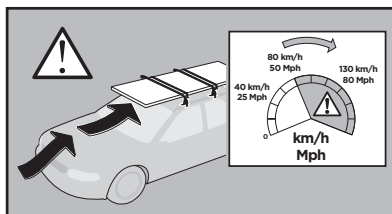
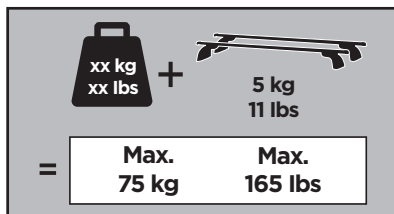
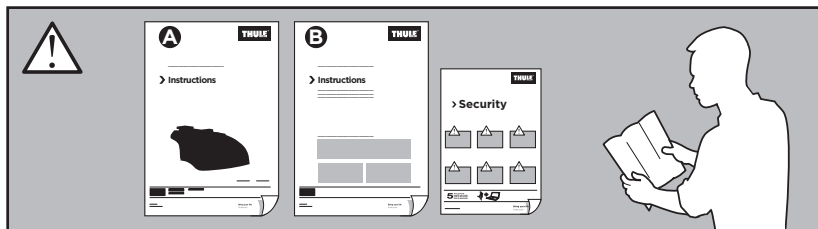

ISO 11154-E

183071

C.20130604
509-3071-01

Bring your life
thule.com

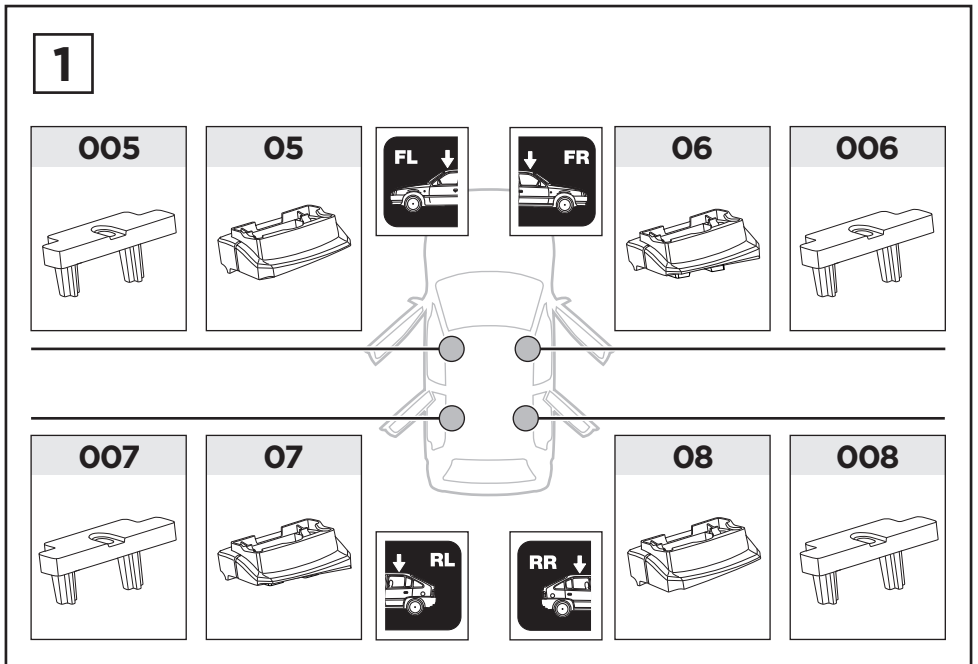
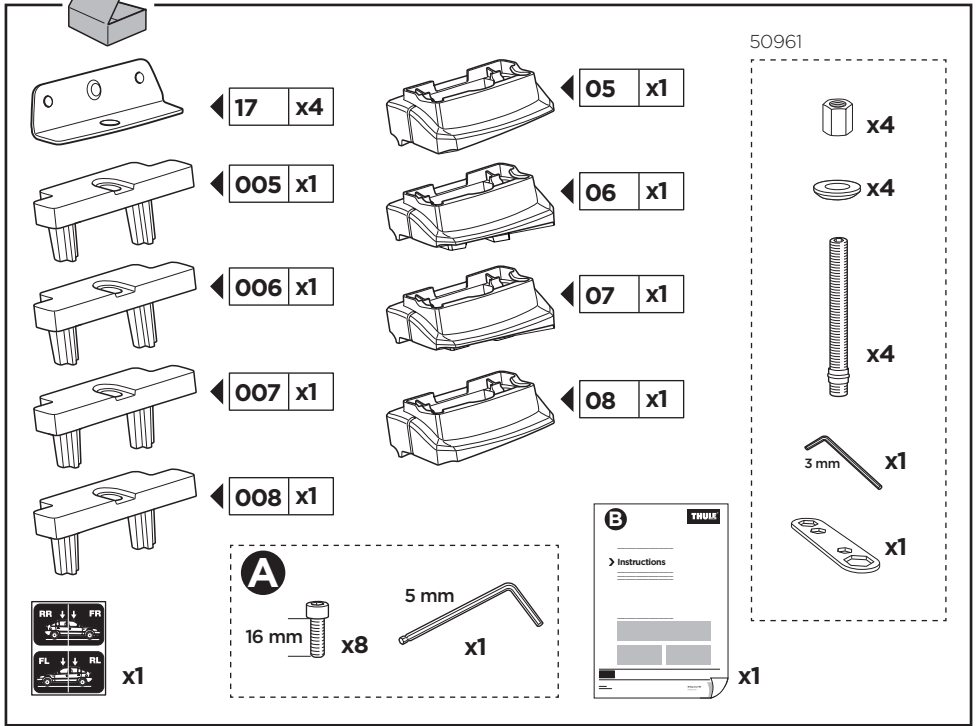

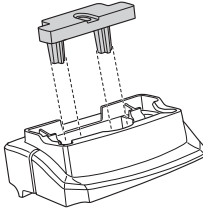
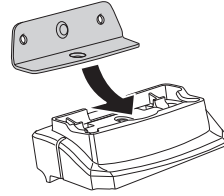
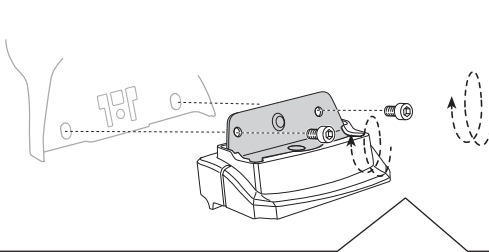
2**A****B****C****A**

16 mm x8

EN Only a few turns
DE Nur wenige Umdrehungen
FR Quelques tours uniquement
NL Slechts enkele slagen
IT Solo qualche giro
ES Sólo algunas vueltas
PT Noções básicas
SV Endast några varv
DK Kun nogle få omgange
NE Bare noen få omdreininger
FI Vain muutama kierros

ET Ainult mõni pööre
LV Tikai dažī apgriezieni
LT Tik keli pasukimai
PL Wystarczy kilka obrotów
RU Только несколько оборотов
UK Лише декілька обертів
BG Само няколко завъртания
CS Pouze několik otáček
SK Len niekoľko otáčok
SL Le nekaj obratov
HR/BIH Samo nekoliko okreta

RO Doar câteva rotiri
HU Csak néhány fordítás
EL Μόνο λίγες περιστροφές
TR Yalnızca birkaç tur
AR بعض دورات فقط
HE רק מספר סיבובים
ZH 仅几圈
JA 2～3回転のみ
KO 몇 번만 돌리면 됨
TH เพียงสองสามรอบ

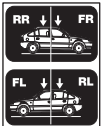
3

x1

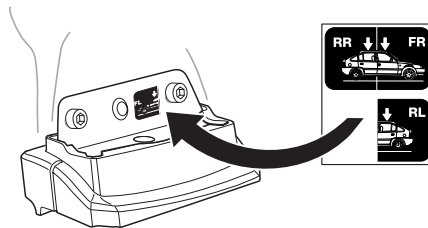

4



A

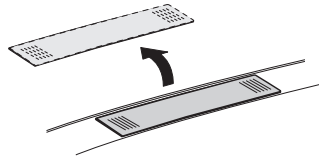
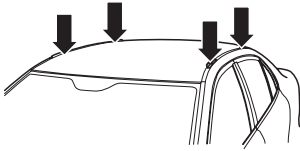

B

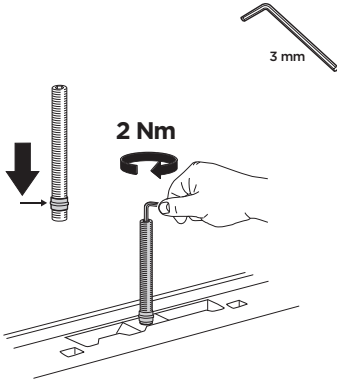

C

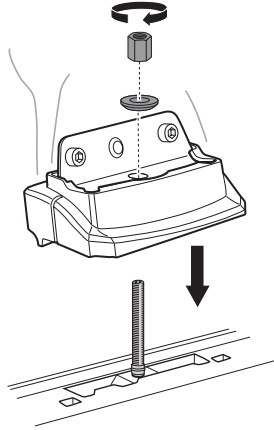

5

A

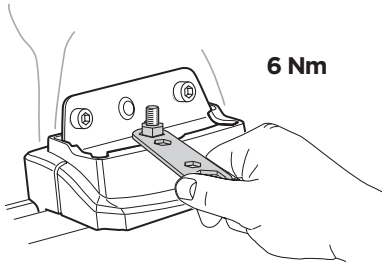
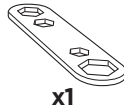

B

