

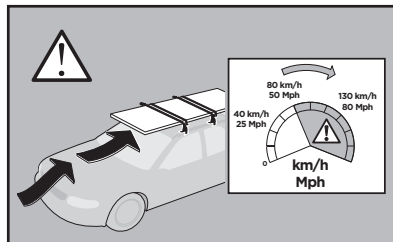

Thule Rapid System Kit 1775

> Instructions

VOLKSWAGEN Passat, 4-dr Sedan, 12-

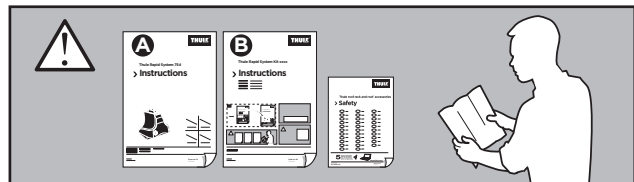
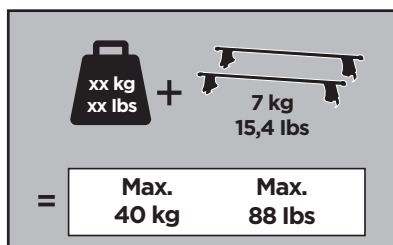
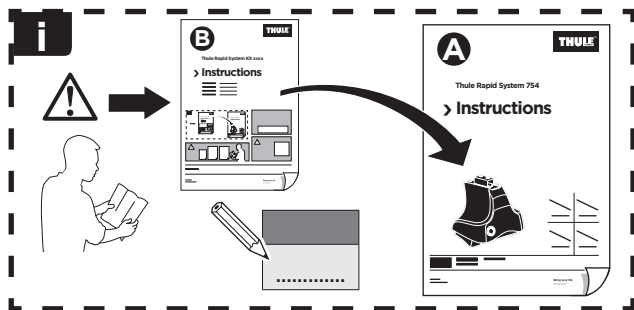

ISO 11154-E

141775
C.20160314
519-1775-02

Bring your life
thule.com



452 x1

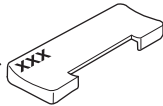

453 x1

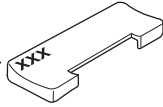

454 x2

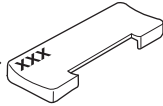

1261 x4



x1



x1

1

	X (scale)	X (mm)	X (inch)
VOLKSWAGEN Passat, 4-dr Sedan, 12-	42,5	1076	42 ³/₈

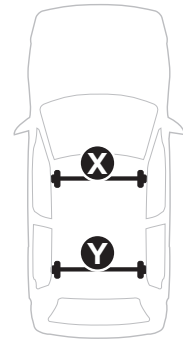
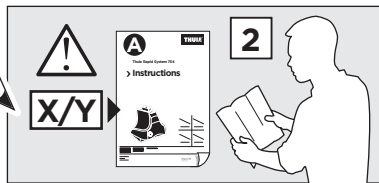
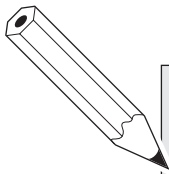

	Y (scale)	Y (mm)	Y (inch)
VOLKSWAGEN Passat, 4-dr Sedan, 12-	38	1031	40 ⁵/₈

2

VOLKSWAGEN Passat, 4-dr Sedan, 12-

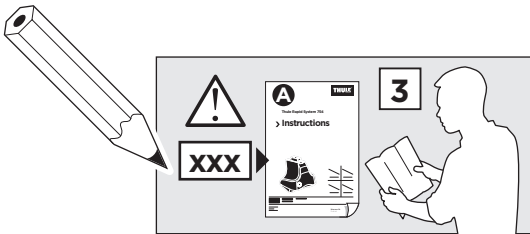
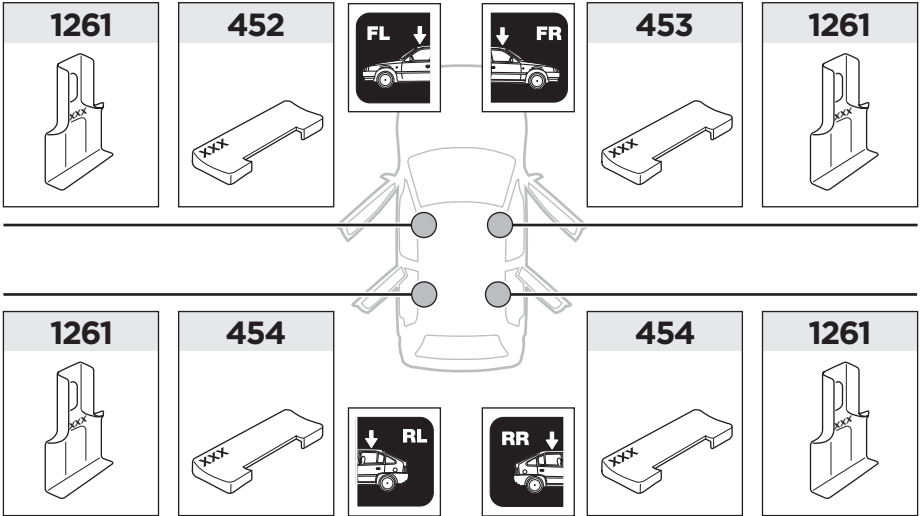

3

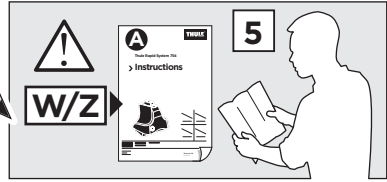

	W (mm)	Z (mm)	W (inch)	Z (inch)
VOLKSWAGEN Passat, 4-dr Sedan, 12-	250	700	9 7/8	27 1/2

