

Thule Rapid System Kit 1616

> Instructions

DODGE Durango, 5-dr SUV, *11-

*North America

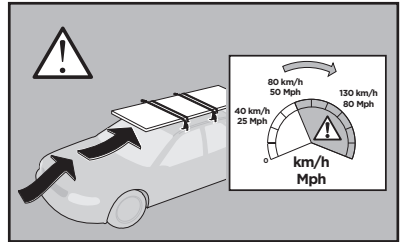
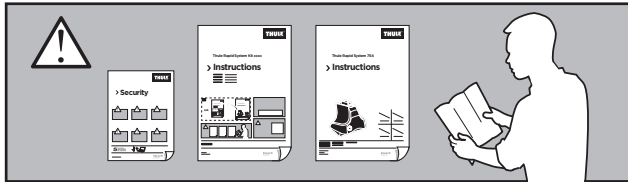
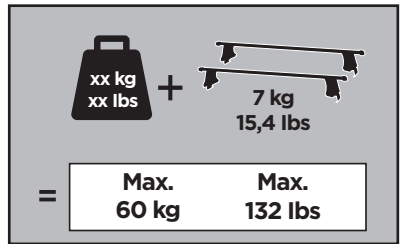
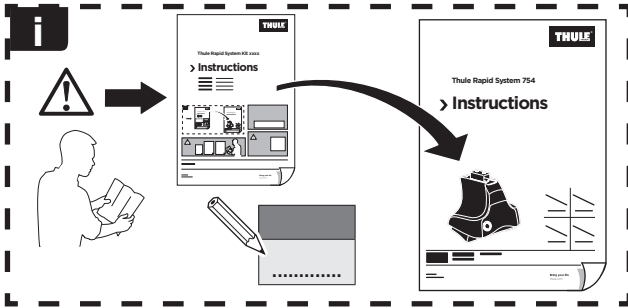

ISO 11154-E

141616

C.20130107
519-1616-01

Bring your life
thule.com



204 x1

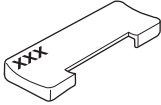

206 x1

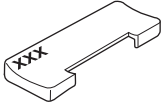

256 x2

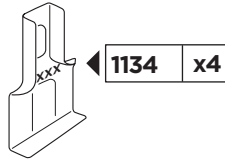
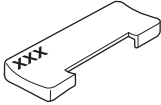

1134 x4



x1

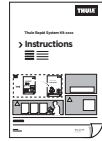

x1

1

	X (scale)	X (mm)	X (inch)
DODGE Durango, 5-dr SUV, *11-	52,5	1176	46 ³/₈

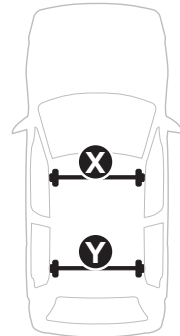
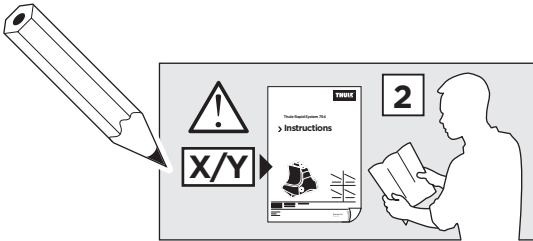

	Y (scale)	Y (mm)	Y (inch)
DODGE Durango, 5-dr SUV, *11-	53	1181	46 ¹/₂

2

DODGE Durango, 5-dr SUV, *11-

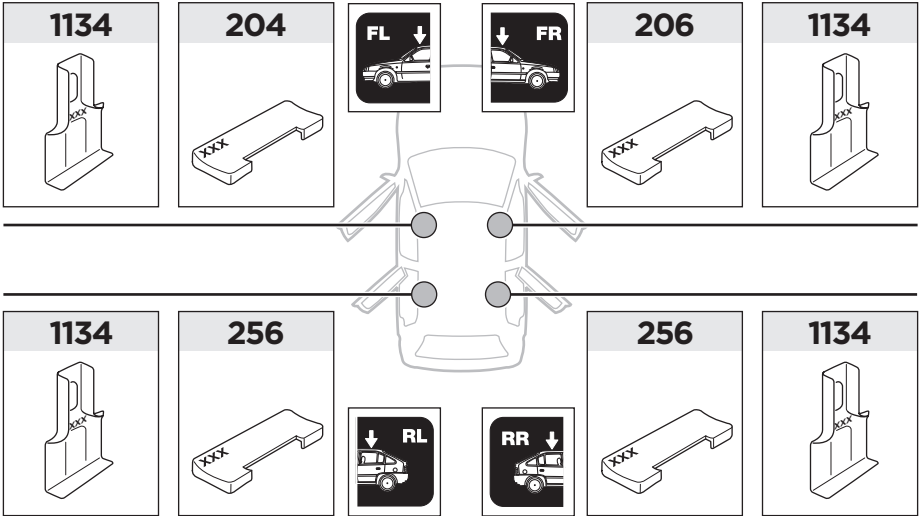

3

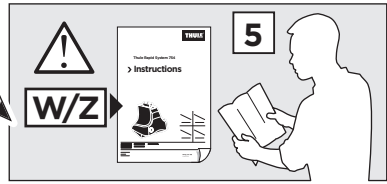

	W (mm)	Z (mm)	W (inch)	Z (inch)
DODGE Durango, 5-dr SUV, *11-	273	750	10 ³/₄	29 ¹/₂

