

# Kit 1578

MITSUBISHI Galant, 4-dr Sedan, \*04-09

\*North America

480R  
754

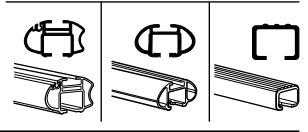
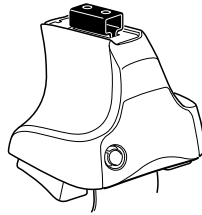

480

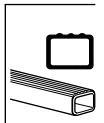
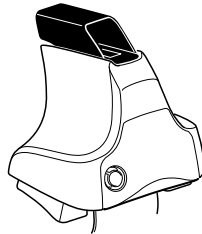

750

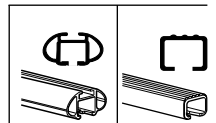
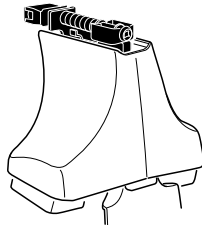

|                      |    |                      |          |    |
|----------------------|----|----------------------|----------|----|
|                      |    |                      |          |    |
| x2<br>x2<br>x2<br>x4 | x2 | x2<br>x2<br>x4<br>x4 | x2<br>x2 | x2 |

**610** x2

**611** x2

**178** x4

x1

**Kit**



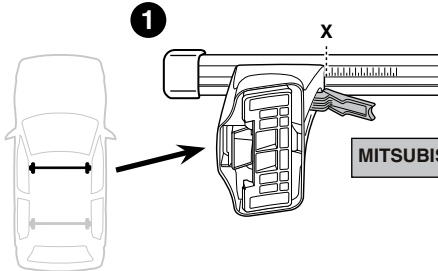

MITSUBISHI Galant, 4-dr Sedan, \*04-09

X

29

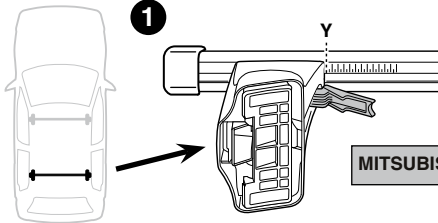
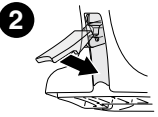

MITSUBISHI Galant, 4-dr Sedan, \*04-09

Y

26,5

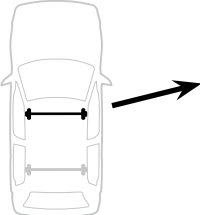
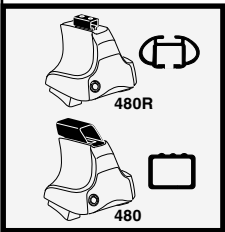
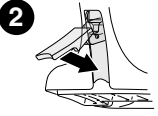

MITSUBISHI Galant, 4-dr Sedan, \*04-09

X inch

X mm

37"

941 mm

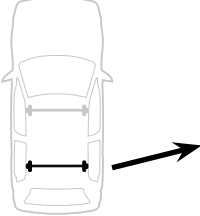
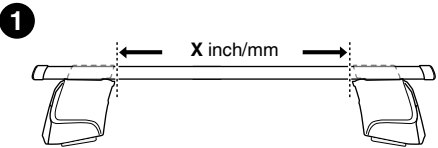

MITSUBISHI Galant, 4-dr Sedan, \*04-09

Y inch

Y mm

36 1/8"

916 mm

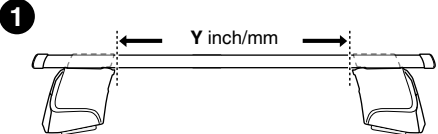

4

MITSUBISHI Galant, 4-dr Sedan, \*04-09

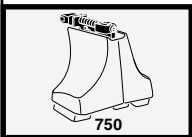
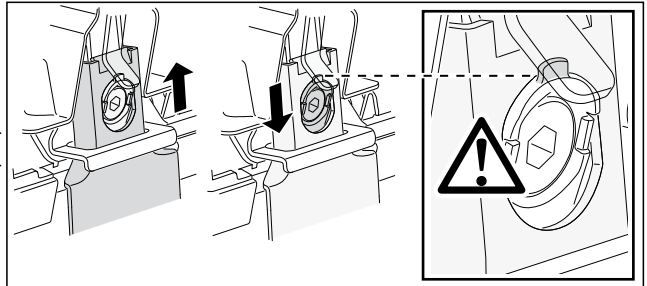
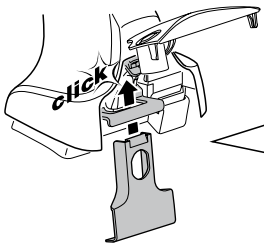
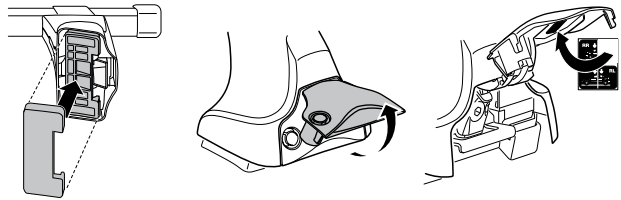
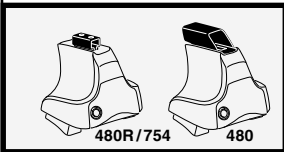
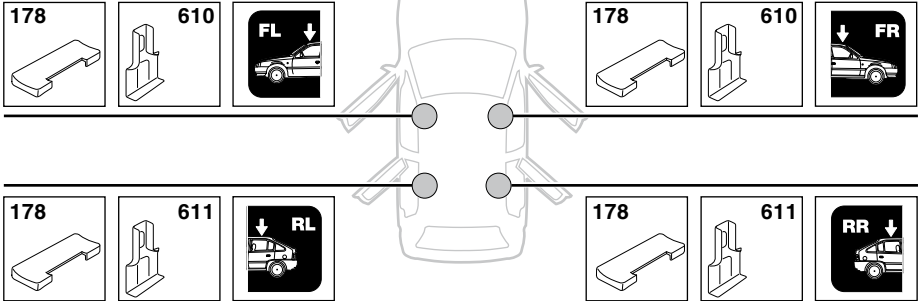

5

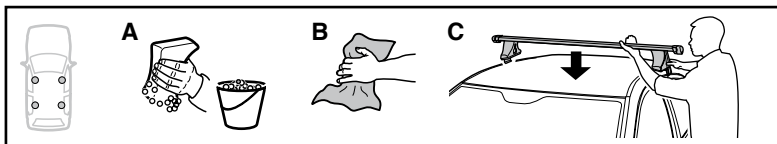

|                                       | X mm   | Y mm   | X inch | Y inch |
|---------------------------------------|--------|--------|--------|--------|
| MITSUBISHI Galant, 4-dr Sedan, *04-09 | 250 mm | 660 mm | 9 3/4" | 26"    |

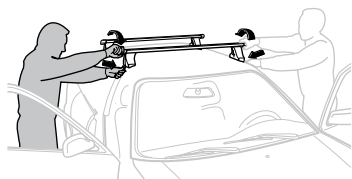
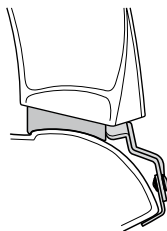
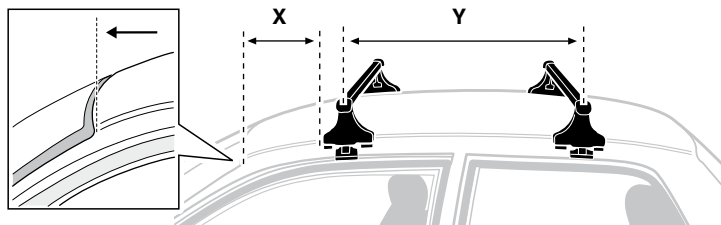

**GB/US** Tighten alternately

**D** Die Schrauben abwechselnd anziehen

**F** Serrer alternativement chaque côté

**NL** Afwisselend aan de linker- en de rechterkant aandraaien

**I** Alternare il serraggio delle viti

**E** Apertar alternativamente

**PT** Aperte alternadamente

**S** Dra åt växelvis

**FIN** Kierrä vuorotellen

**EST** Pinguldage vaheldumisi

**LAT** Pielieciet pamišus

**LIT** Užsukinėkite pakaitomis

**PL** Śruby dokręcaj naprzemiennie

**RU** Затягивайте попеременно

**CZ** Pokręťta багаžníka dokręcaj dokręcaj naprzemiennie.

**SK** Doťahujte striedavo

**SLO** Privijajte izmenično.

**HR** Naizmjenično zategnite

**HU** Egymástól függetlenül szorítandó

**GR** Σφιγγετε εναλλάξ

**TR** Dönüşümlü sıkın

**中文** 交替拧紧

**한국어** 번갈아 가며 조이십시오.

**日本語** 交互に締め付けてください。

**ไทย** ชันโนแบบสลับ

6



480R/754



480



\*  
3 Nm



\*



\*  
≈ 3 Nm

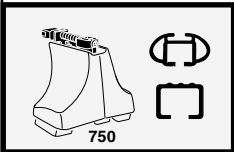

750

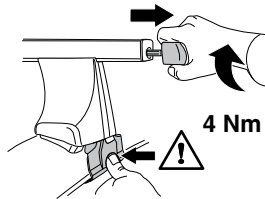

4 Nm

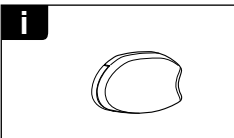
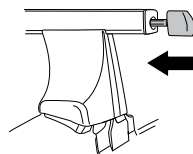

i

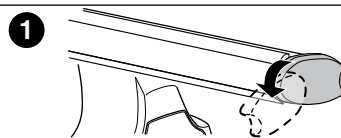

1

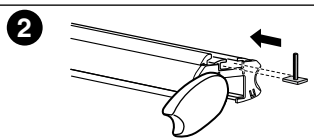

2

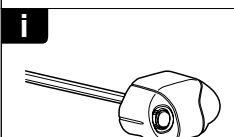

i

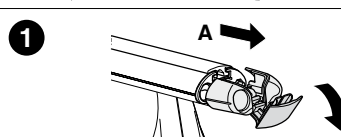

1

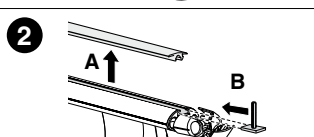

2

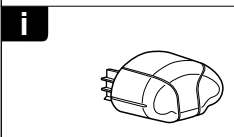

i

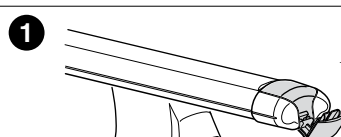

1

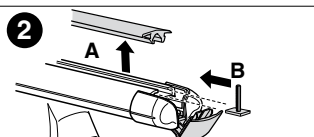

2

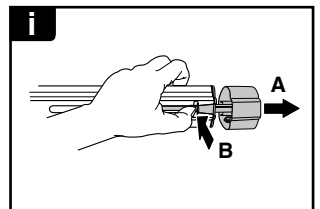
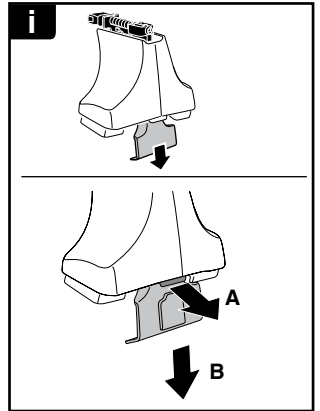

**THULE**  
SWEDEN  
**ONE  
KEY  
SYSTEM**



|      |  |       |
|------|--|-------|
|      |  | (x4)  |
|      |  | (x6)  |
|      |  | (x8)  |
| NA   |  | (x10) |
| EUR  |  | (x12) |
| ASIA |  | (x12) |



ww ▶ Thule Sweden AB, Box 69, 330 33 Hillerstorp, SWEDEN  
NA ▶ Thule Inc., 42 Silvermine Road, Seymour, Connecticut 06483, USA

info@thule.com  
customer.service@thule.com

www.thule.com