



## Thule Rapid System Kit 1551

# > Instructions

**INFINITI G25**, 4-dr Sedan, \*10-

**INFINITI G35**, 4-dr Sedan, \*07-

**INFINITI G37**, 4-dr Sedan, \*09-

\*North America

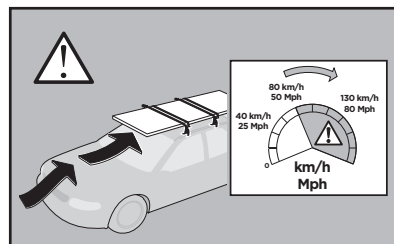
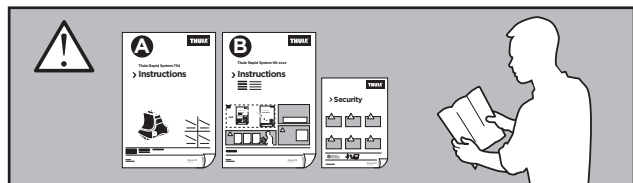
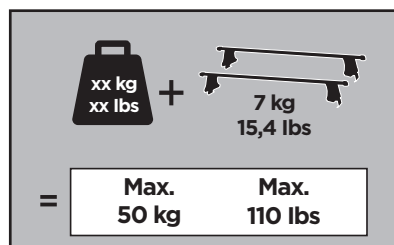
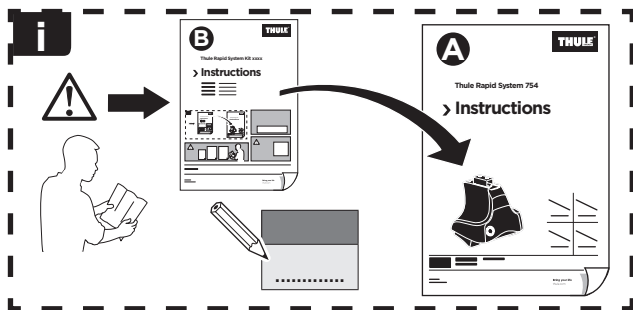

ISO 11154-E

141551

C.20130625  
519-1551-02

Bring your life  
thule.com



284 x1



285 x1

286 x1

287 x1



670 x2



775 x2



x1



x1

1

	X (scale)	X (mm)	X (inch)
<b>INFINITI G25</b> , 4-dr Sedan, *10-	37	1021	40 1/4
<b>INFINITI G35</b> , 4-dr Sedan, *07-	37	1021	40 1/4
<b>INFINITI G37</b> , 4-dr Sedan, *09-	37	1021	40 1/4

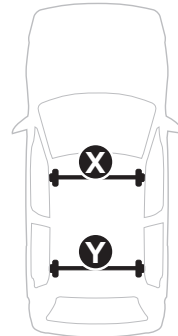
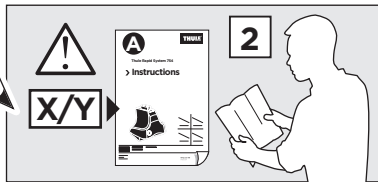
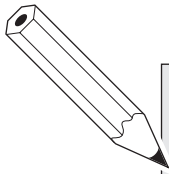

	Y (scale)	Y (mm)	Y (inch)
<b>INFINITI G25</b> , 4-dr Sedan, *10-	34,5	996	39 1/4
<b>INFINITI G35</b> , 4-dr Sedan, *07-	34,5	996	39 1/4
<b>INFINITI G37</b> , 4-dr Sedan, *09-	34,5	996	39 1/4

# 2

**INFINITI G25**, 4-dr Sedan, \*10-

**INFINITI G35**, 4-dr Sedan, \*07-

**INFINITI G37**, 4-dr Sedan, \*09-

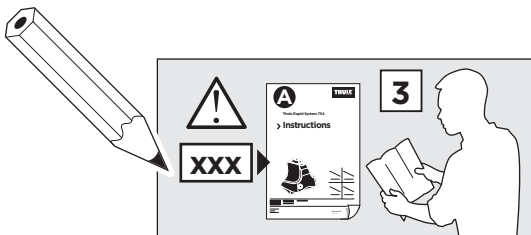
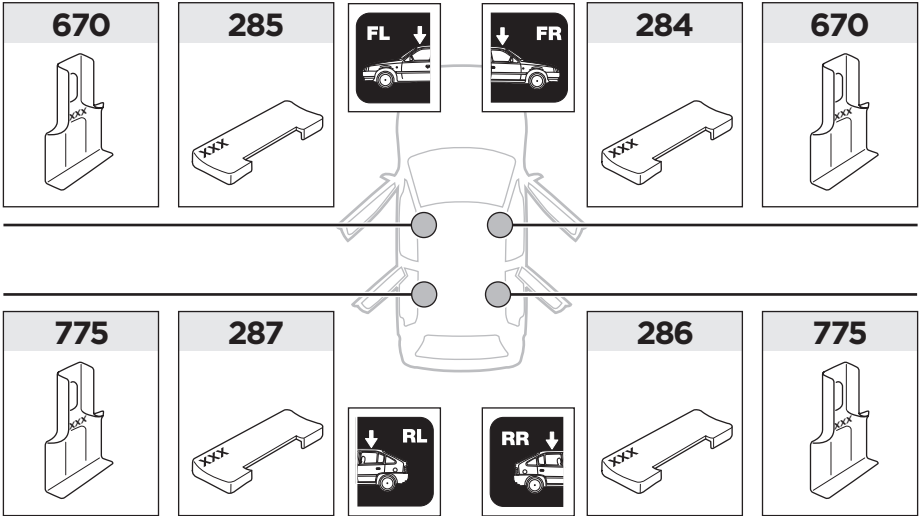

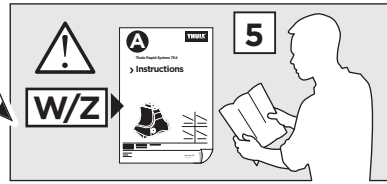
**3**

	W (mm)	Z (mm)	W (inch)	Z (inch)
<b>INFINITI G25</b> , 4-dr Sedan, *10-	<b>270</b>	<b>685</b>	<b>10 1/2</b>	<b>27</b>
<b>INFINITI G35</b> , 4-dr Sedan, *07-	<b>270</b>	<b>685</b>	<b>10 1/2</b>	<b>27</b>
<b>INFINITI G37</b> , 4-dr Sedan, *09-	<b>270</b>	<b>685</b>	<b>10 1/2</b>	<b>27</b>

