

Kit 1404

MITSUBISHI 380, 4-dr Sedan, 05-08

480R
754

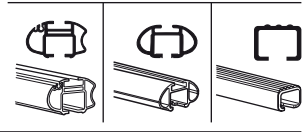
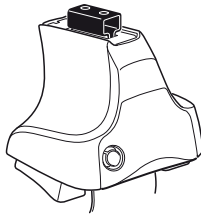

480

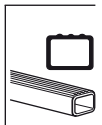
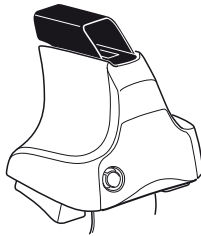

750

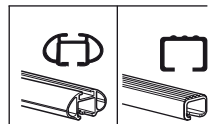
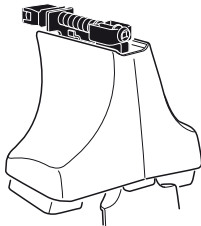

Max. 60kg
Max. 132 lbs

x1
 x4
 x4
 x4
 x4

480R/754

x1
 x4
 x4
 x4

480

x1
 x4
 x4

750

x2 x2 x2 x4	x2	x2 x2 x4 x4	x2 x2	x2

← **667** x 1
 ← **766** x 1
 ← **19** x 2

← **669** x 1
 ← **767** x 1
 ← **68** x 1

← **69** x 1

x 1

Kit



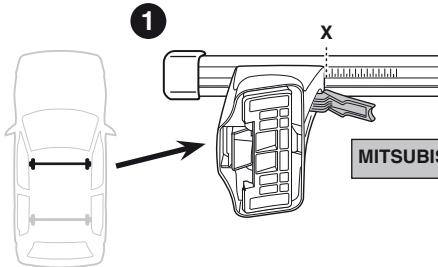

MITSUBISHI 380, 4-dr Sedan, 05-08	X
	45

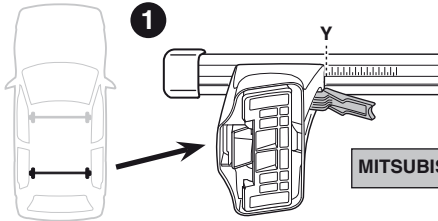

MITSUBISHI 380, 4-dr Sedan, 05-08	Y
	39

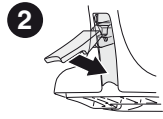
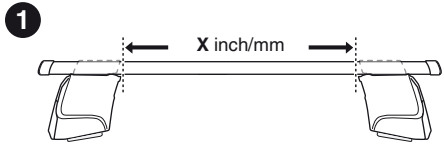
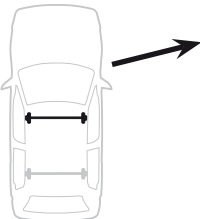
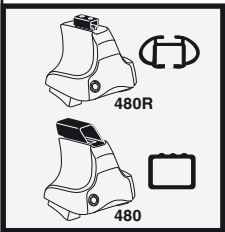

MITSUBISHI 380, 4-dr Sedan, 05-08	X inch	X mm
	43 3/8"	1101 mm

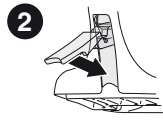
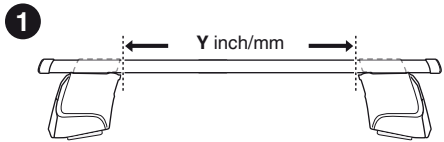
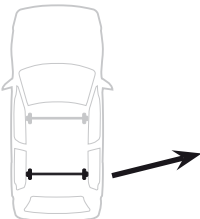

MITSUBISHI 380, 4-dr Sedan, 05-08	Y inch	Y mm
	41"	1041 mm

4

MITSUBISHI 380, 4-dr Sedan, 05-08

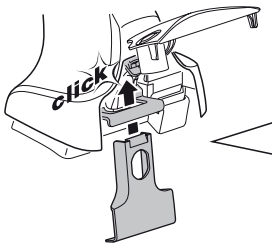
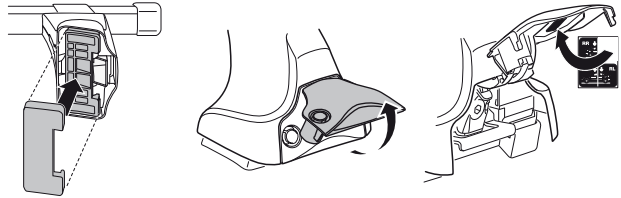
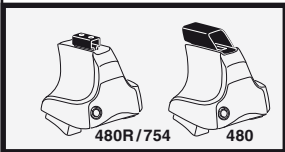
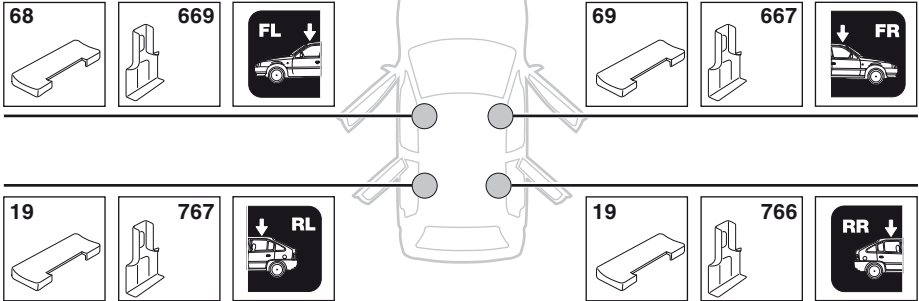

5



	X mm	Y mm	X inch	Y inch
MITSUBISHI 380, 4-dr Sedan, 05-08	250 mm	750 mm	9 7/8"	29 1/2"

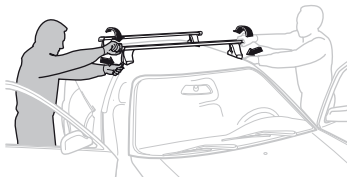
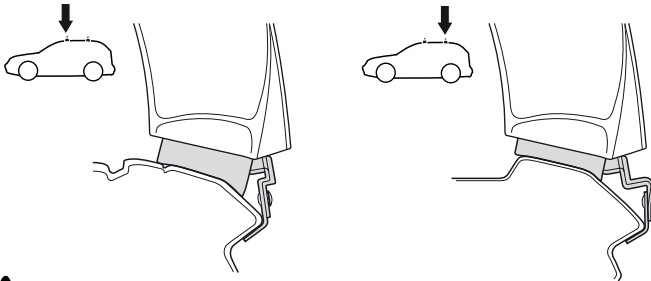
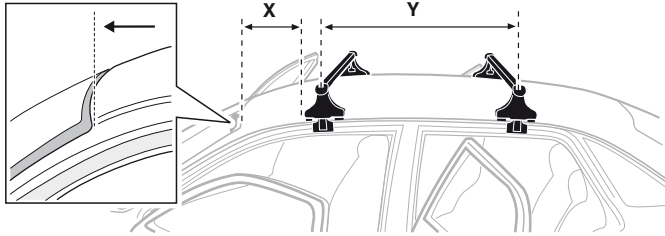

GB/US Tighten alternately

D Die Schrauben abwechselnd anziehen

F Serrer alternativement chaque côté

NL Afwisselend aan de linker- en de rechterkant aandraaien

I Alternare il serraggio delle viti

E Apretar alternativamente

PT Aperte alternadamente

S Dra åt växelvis

FIN Kierrä vuorotellen

EST Pinguldage vaheldumisi

LAT Pielieciet pamišus

LIT Užsukinėkite pakaitomis

PL Śruby dokręcaj naprzemiennie

RU Затягивайте попеременно

CZ Pokręťta багаžníka dokręcaj dokręcaj naprzemiennie.

SK Doťahujte striedavo

SLO Privijajte izmenično.

HR Naizmjenično zategnite

HU Egymástól függetlenül szorítandó

GR Σφιγγετε εναλλάξ

TR Dönüşümlü sıkın

中文 交替拧紧

한국어 번갈아 가며 조이십시오.

日本語 交互に締め付けてください。

ไทย ชันโนแบบสลับ

6



480R/754



480

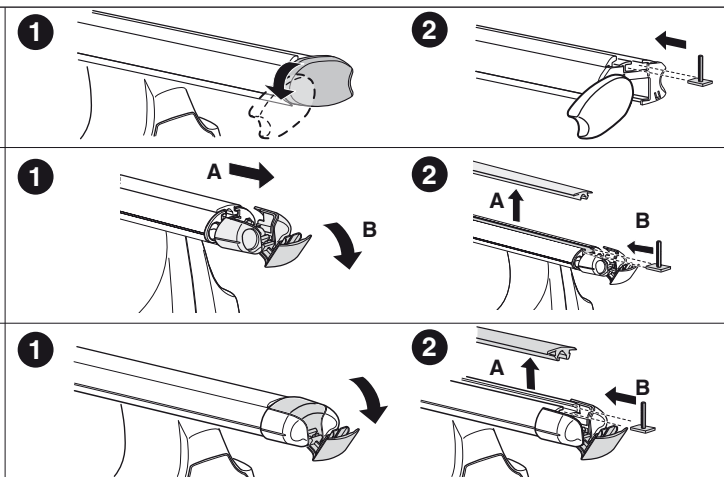
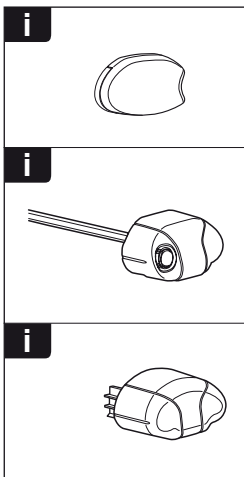
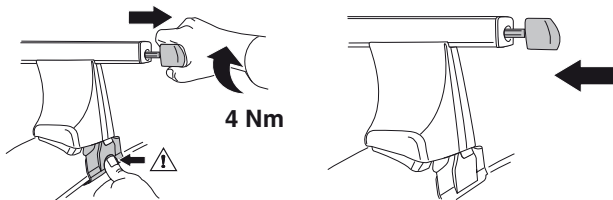
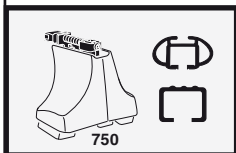
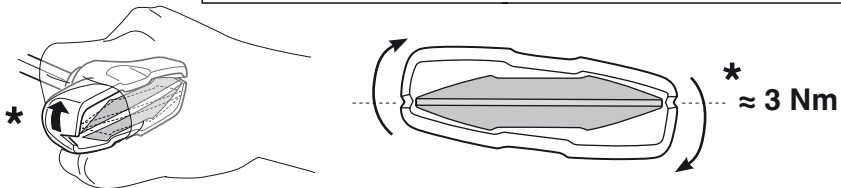
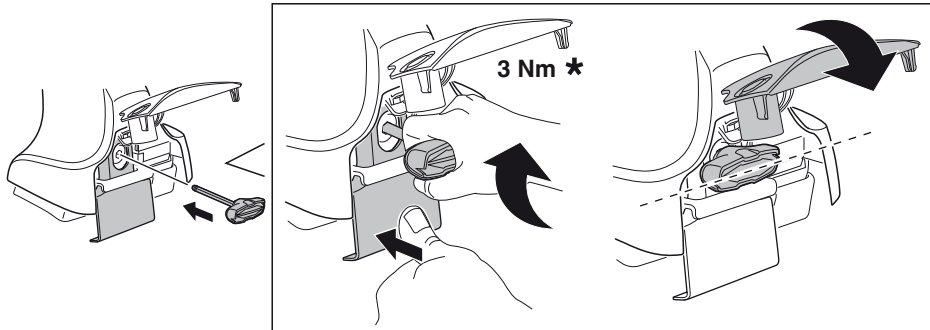

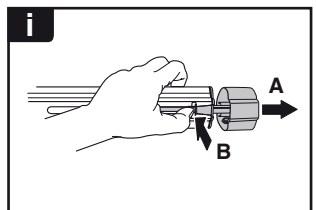
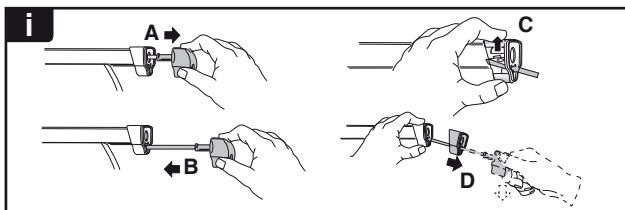
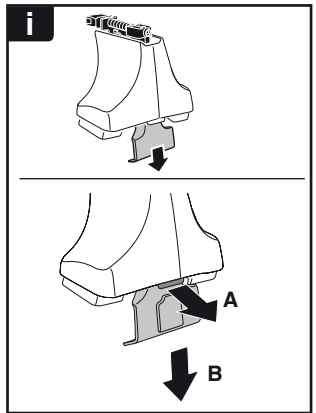
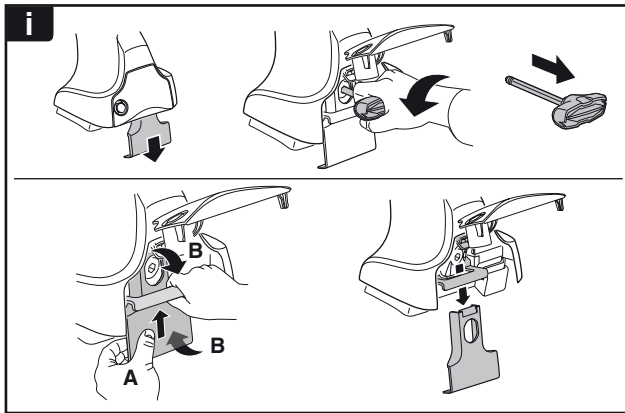
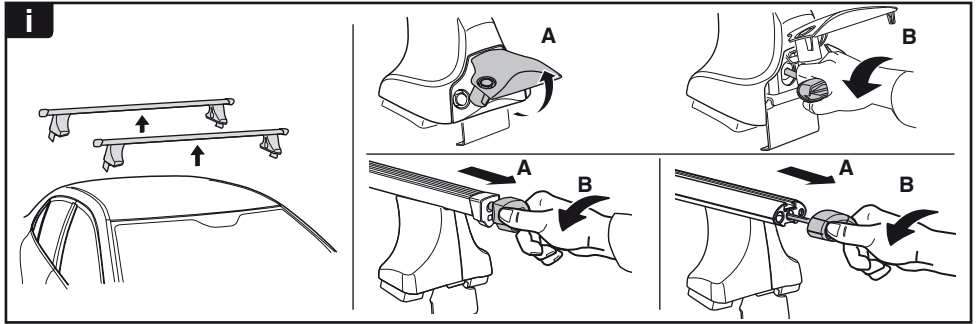

THULE
SWEDEN
**ONE
KEY
SYSTEM**

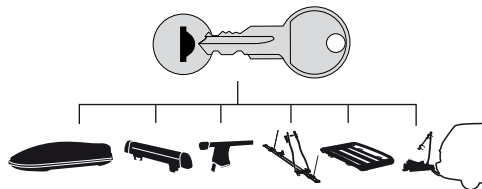

- 544 (x4)
- 596 (x6)
- 588 (x8)
- NA 510 (x10)
- EUR 452 (x12)
- ASIA

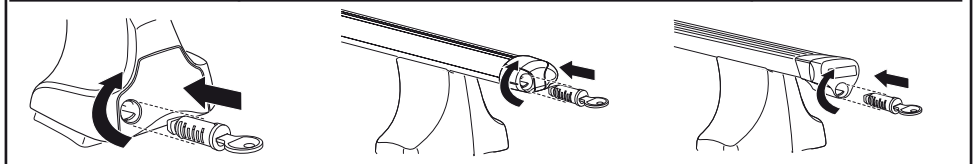

WW ▶ Thule Sweden AB, Box 69, 330 33 Hillerstorp, SWEDEN
NA ▶ Thule Inc., 42 Silvermine Road, Seymour, Connecticut 06483, USA

info@thule.com
customer.service@thule.com

www.thule.com