

# Kit 1374

FORD Ecosport, 5-dr SUV, 03-

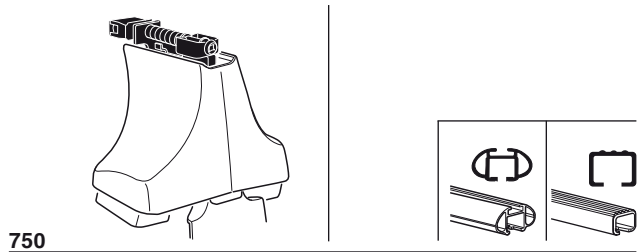

**Kit**

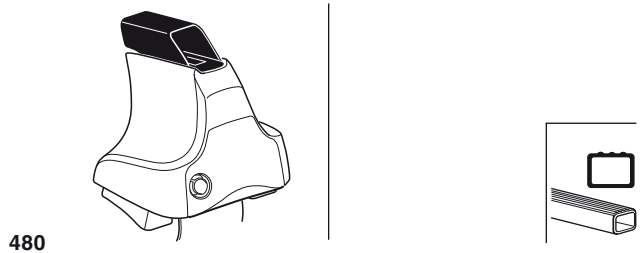
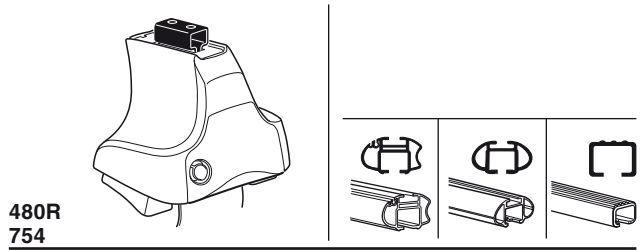
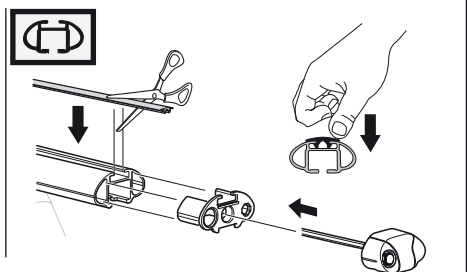
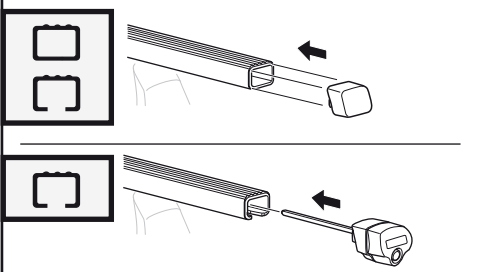
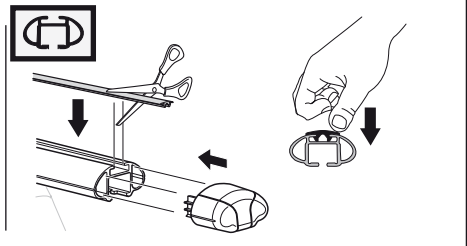
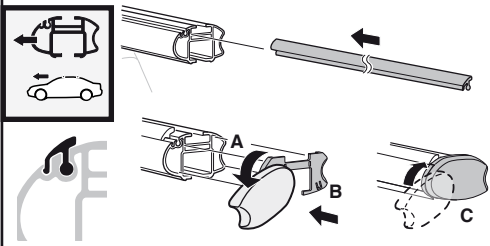

**3**



754

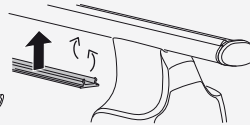
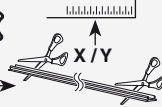

750



**1**

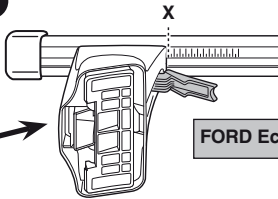

**2**

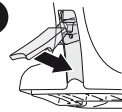

FORD Ecosport, 5-dr SUV, 03-

X

33



**1**

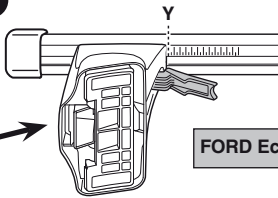

**2**

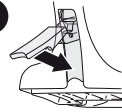

FORD Ecosport, 5-dr SUV, 03-

Y

28



480R



480

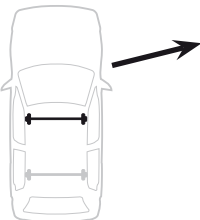

**1**

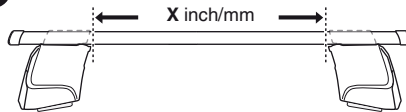

**2**

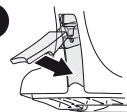

FORD Ecosport, 5-dr SUV, 03-

X inch

X mm

38 <sup>5</sup>/<sub>8</sub> "

981 mm

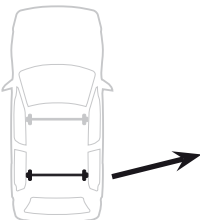

**1**

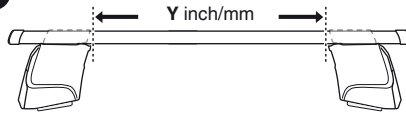

**2**



FORD Ecosport, 5-dr SUV, 03-

Y inch

Y mm

36 <sup>5</sup>/<sub>8</sub> "

931 mm

4

FORD Ecosport, 5-dr SUV, 03-

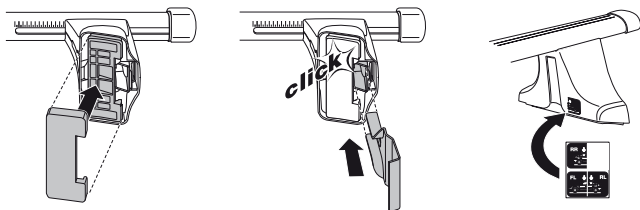
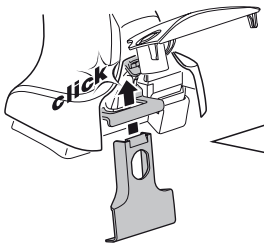
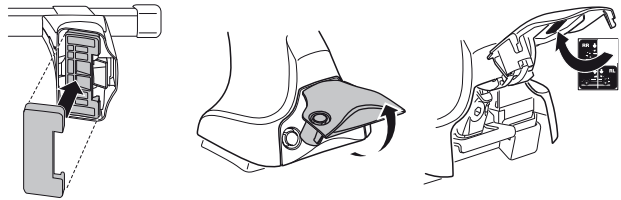
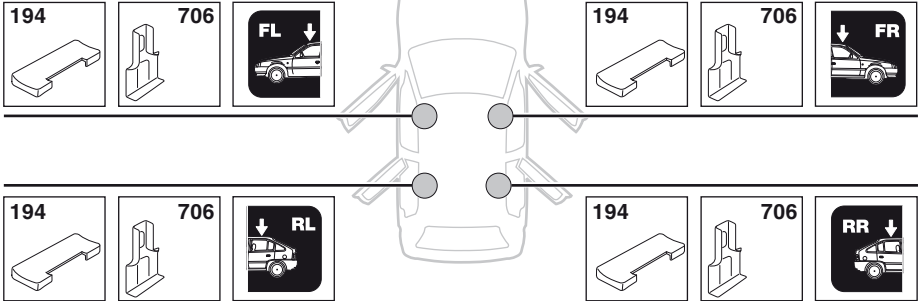

**5**



	X mm	Y mm	X inch	Y inch
<b>FORD Ecosport, 5-dr SUV, 03-</b>	<b>300 mm</b>	<b>700 mm</b>	<b>11 3/4"</b>	<b>27 1/2"</b>

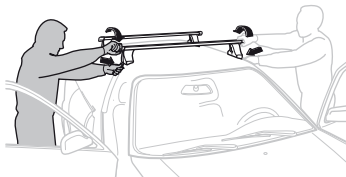
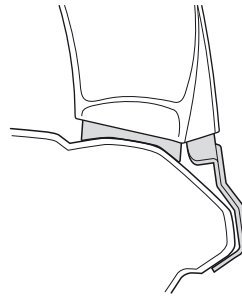
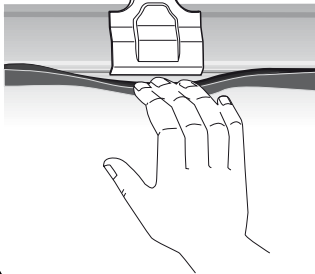
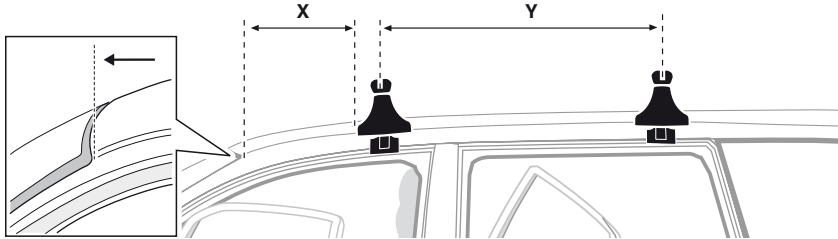

**GB/US** Tighten alternately

**D** Die Schrauben abwechselnd anziehen

**F** Serrer alternativement chaque côté

**NL** Afwisselend aan de linker- en de rechterkant aandraaien

**I** Alternare il serraggio delle viti

**E** Apretar alternativamente

**PT** Aperte alternadamente

**S** Dra åt växelvis

**FIN** Kierrä vuorotellen

**EST** Pinguldage vaheldumisi

**LAT** Pielieciet pamišus

**LIT** Užsukinėkite pakaitomis

**PL** Śruby dokręcaj naprzemiennie

**RU** Затягивайте попеременно

**CZ** Pokręťta багаžníka dokręcaj dokręcaj naprzemiennie.

**SK** Doťahujte striedavo

**SLO** Privijajte izmenično.

**HR** Naizmjenično zategnite

**HU** Egymástól függetlenül szorítandó

**GR** Σφιγγετε εναλλάξ

**TR** Dönüşümlü sıkın

**中文** 交替拧紧

**한국어** 번갈아 가며 조이십시오.

**日本語** 交互に締め付けてください。

**ไทย** ชันโนแบบสลับ

6



480R/754



480

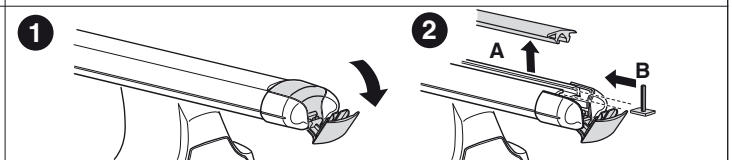
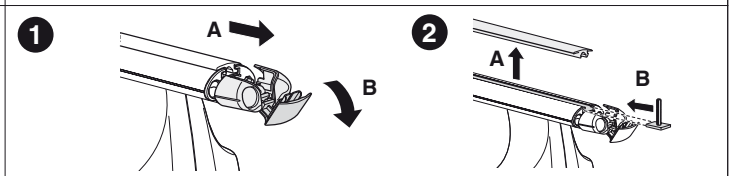
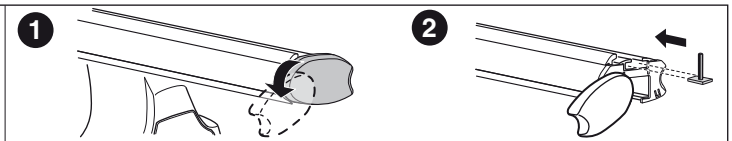
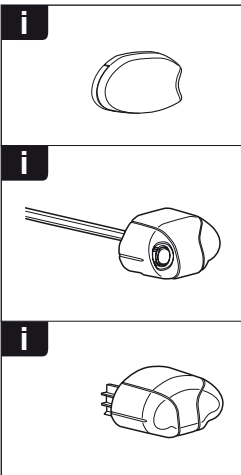
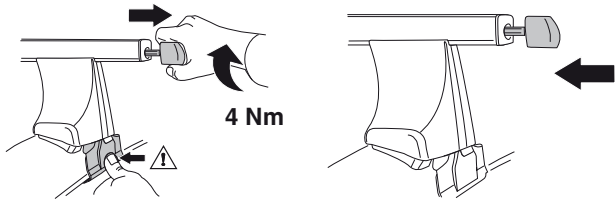
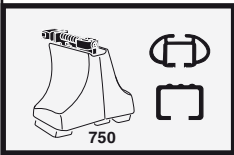
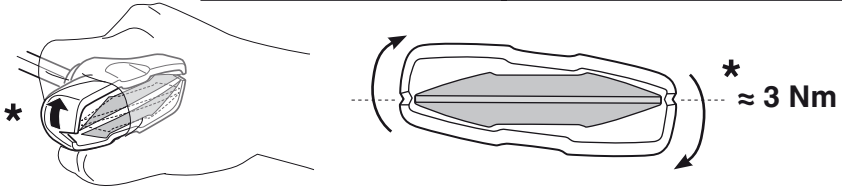
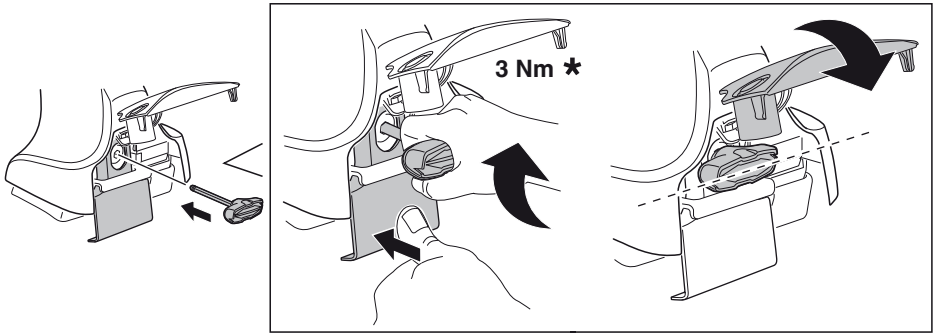

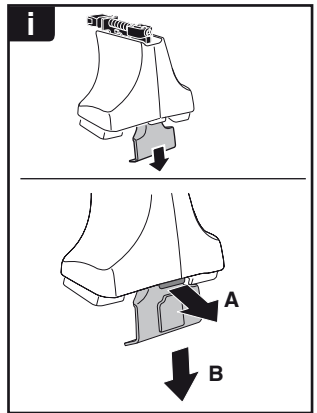
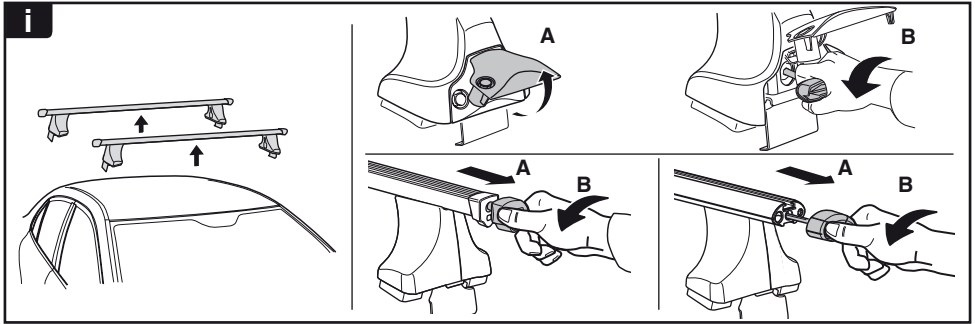

**THULE**  
SWEDEN  
**ONE  
KEY  
SYSTEM**



		544	(x4)
		596	(x6)
		588	(x8)
NA		510	(x10)
EUR		452	(x12)
ASIA			



WW ▶ Thule Sweden AB, Box 69, 330 33 Hillerstorp, SWEDEN  
NA ▶ Thule Inc., 42 Silvermine Road, Seymour, Connecticut 06483, USA

info@thule.com  
customer.service@thule.com

www.thule.com