

Kit 1232

TOYOTA Corolla Verso II, 5-dr MPV, 02-06

TOYOTA Spacio II, 5-dr MPV, 01-06

480R
754

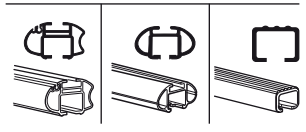
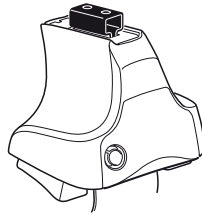

480

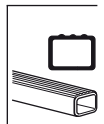
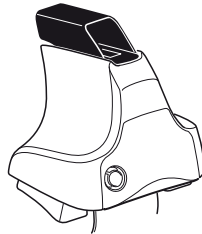

750

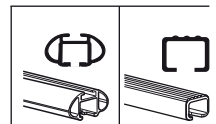
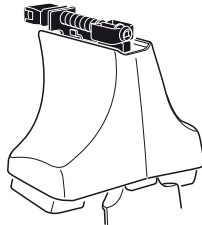

x2 x2 x2 x4	x2	x2 x2 x4 x4	x2 x2	x2	x2

Kit

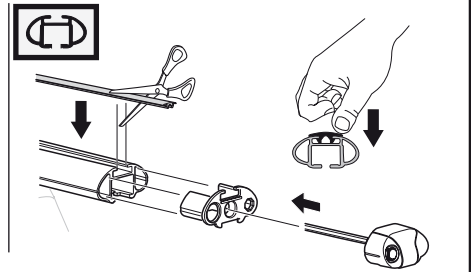
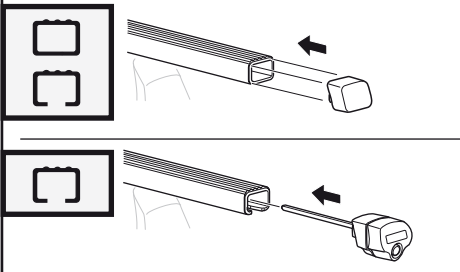
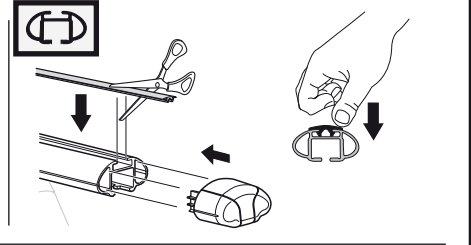
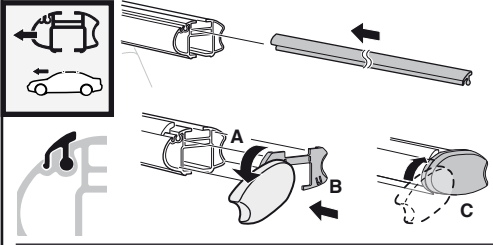
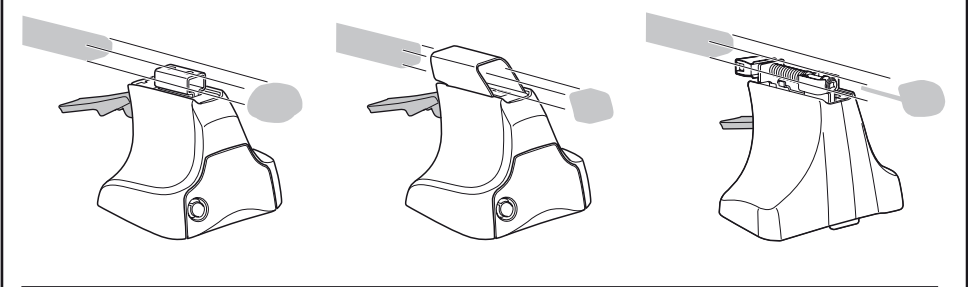
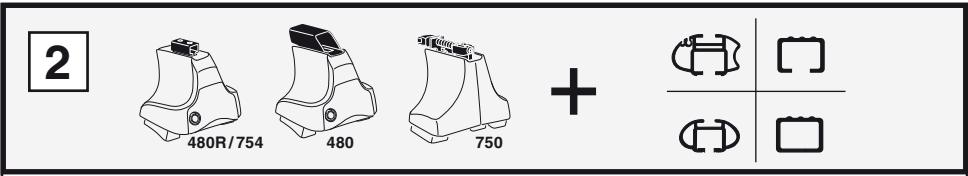
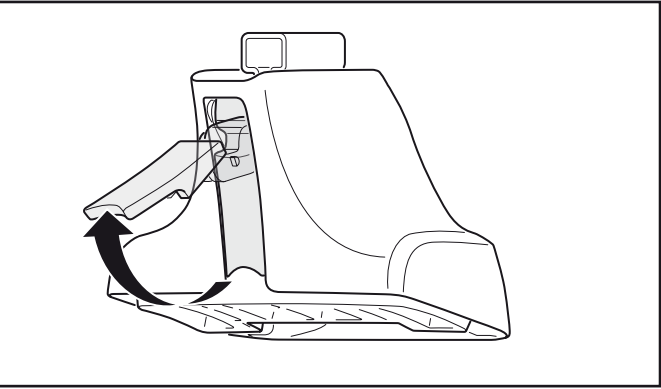
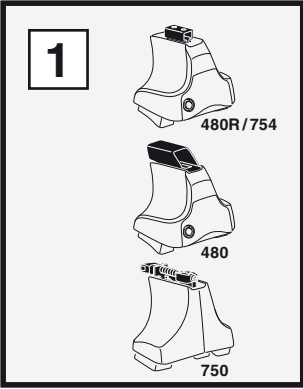

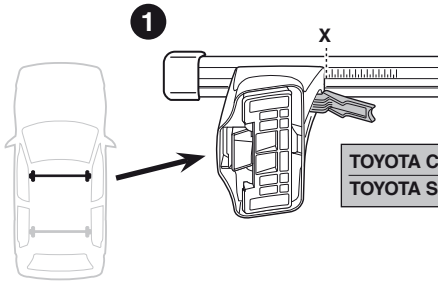

	X
TOYOTA Corolla Verso II, 5-dr MPV, 02-06	37,5
TOYOTA Spacio II, 5-dr MPV, 01-06	37,5

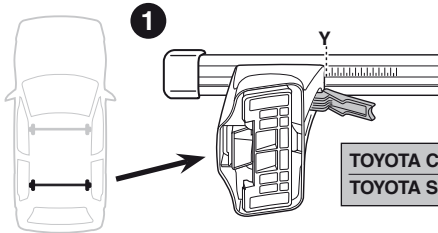

	Y
TOYOTA Corolla Verso II, 5-dr MPV, 02-06	34,5
TOYOTA Spacio II, 5-dr MPV, 01-06	34,5

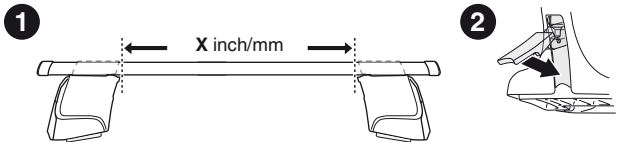
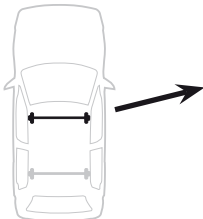
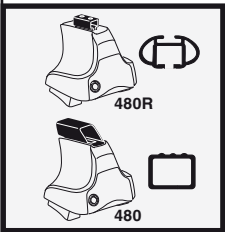

	X inch	X mm
TOYOTA Corolla Verso II, 5-dr MPV, 02-06	40 ³ / ₈ "	1026 mm
TOYOTA Spacio II, 5-dr MPV, 01-06	40 ³ / ₈ "	1026 mm

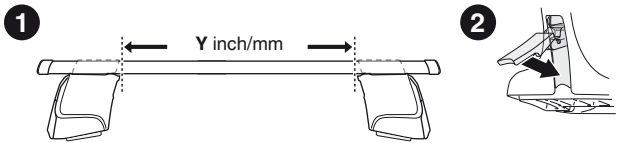
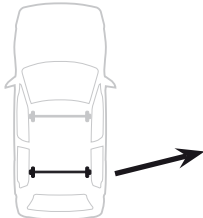

	Y inch	Y mm
TOYOTA Corolla Verso II, 5-dr MPV, 02-06	39 ¹ / ₄ "	996 mm
TOYOTA Spacio II, 5-dr MPV, 01-06	39 ¹ / ₄ "	996 mm

4

TOYOTA Corolla Verso II, 5-dr MPV, 02-06

TOYOTA Spacio II, 5-dr MPV, 01-06

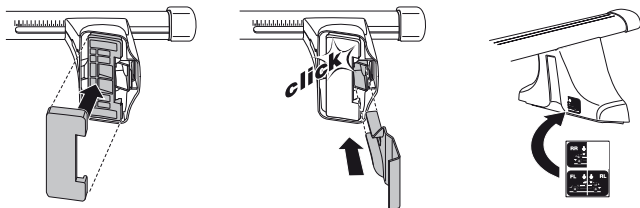
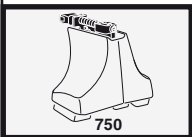
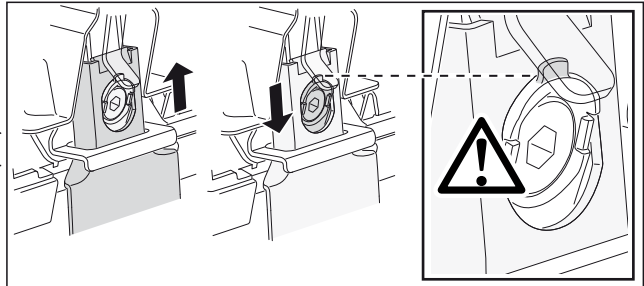
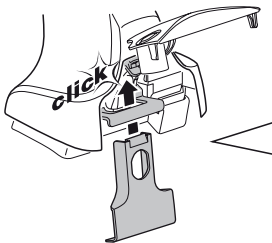
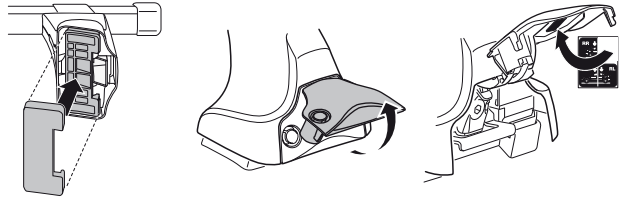
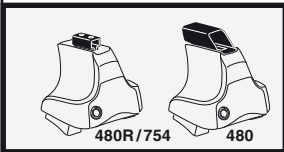
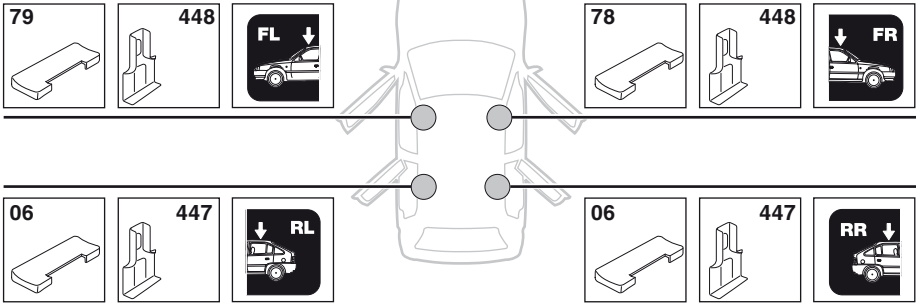

5



	X mm	Y mm	X inch	Y inch
TOYOTA Corolla Verso II, 5-dr MPV, 02-06	310 mm	700 mm	12 1/4"	27 1/2"
TOYOTA Spacio II, 5-dr MPV, 01-06	310 mm	700 mm	12 1/4"	27 1/2"

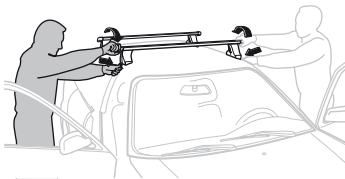
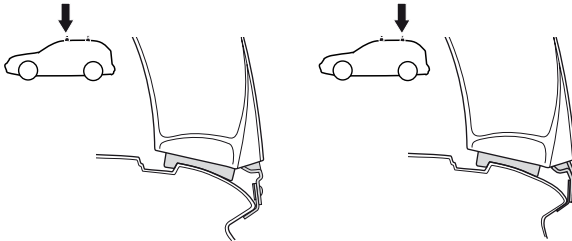
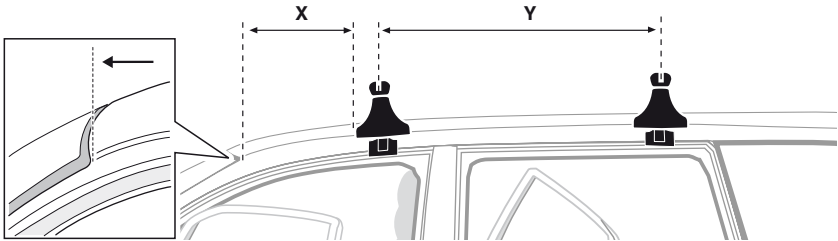

GB/US Tighten alternately

D Die Schrauben abwechselnd anziehen

F Serrer alternativement chaque côté

NL Afwisselend aan de linker- en de rechterkant aandraaien

I Alternare il serraggio delle viti

E Apretar alternativamente

PT Aperte alternadamente

S Dra åt växelvis

FIN Kierrä vuorotellen

EST Pinguldage vaheldumisi

LAT Pievelciēt pamīšus

LIT Užsukinėkite pakaitomis

PL Śruby dokręcaj naprzemiennie

RU Затягивайте попеременно

CZ Pokręťta багаžníka dokręcaj dokręcaj naprzemiennie.

SK Doťahujte striedavo

SLO Privijajte izmenično.

HR Naizmjenično zategnite

HU Egymástól függetlenül szorítandó

GR Σφιγγετε εναλλάξ

TR Dönüşümlü sıkın

中文 交替拧紧

한국어 번갈아 가며 조이십시오.

日本語 交互に締め付けてください。

ไทย ชั้นในแบบสลับ

6



480R/754



480

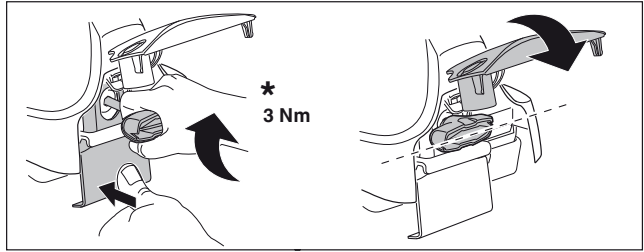
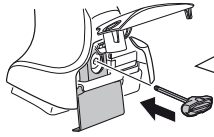

*
3 Nm



*

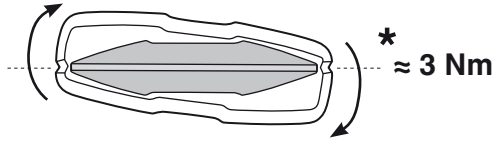

*
≈ 3 Nm

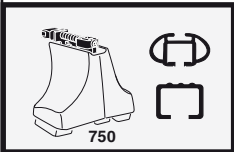
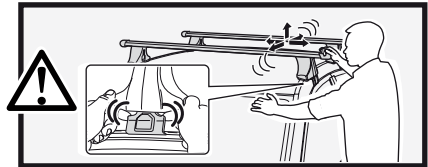

750

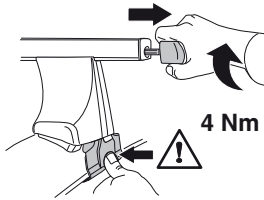

4 Nm

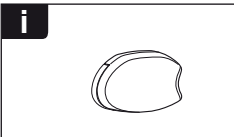
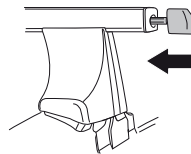

i

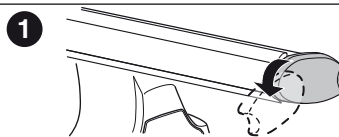

1

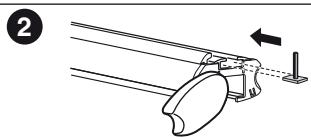

2

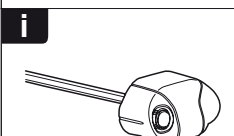

i

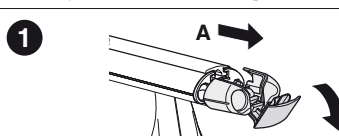

1

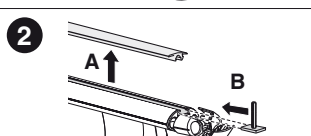

2

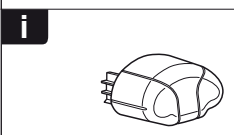

i

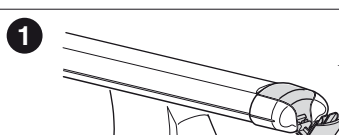

1

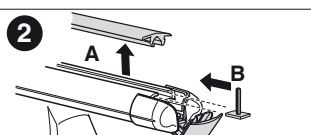

2



THULE
SWEDEN
**ONE
KEY
SYSTEM**



- 544 (x4)
- 596 (x6)
- 588 (x8)
- NA 510 (x10)
- EUR 452 (x12)
- ASIA



WW ▶ Thule Sweden AB, Box 69, 330 33 Hillerstorp, SWEDEN
NA ▶ Thule Inc., 42 Silvermine Road, Seymour, Connecticut 06483, USA

info@thule.com
customer.service@thule.com

www.thule.com