

Kit 1140

TOYOTA Carina, 4-dr Sedan, 96-00
TOYOTA Corona, 4-dr Sedan, 96-00

480R
754

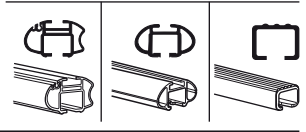
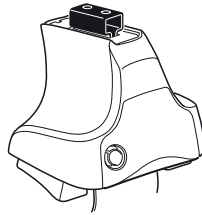

480

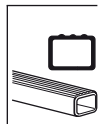
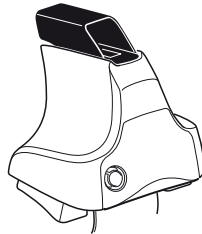

750

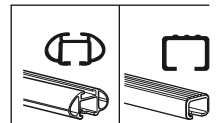
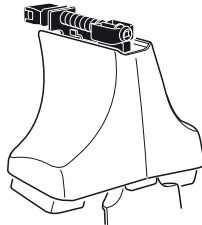



3

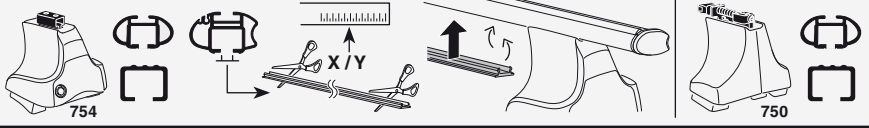

1

2

	X
TOYOTA Carina, 4-dr Sedan, 96-00	26
TOYOTA Corona, 4-dr Sedan, 96-00	25,5

1

2

	Y
TOYOTA Carina, 4-dr Sedan, 96-00	24
TOYOTA Corona, 4-dr Sedan, 96-00	24

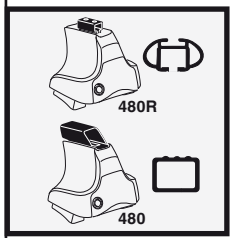

1

2

	X inch	X mm
TOYOTA Carina, 4-dr Sedan, 96-00	35 ⁷ / ₈ "	911 mm
TOYOTA Corona, 4-dr Sedan, 96-00	35 ⁵ / ₈ "	906 mm

1

2

	Y inch	Y mm
TOYOTA Carina, 4-dr Sedan, 96-00	35 ¹ / ₈ "	891 mm
TOYOTA Corona, 4-dr Sedan, 96-00	35 ¹ / ₈ "	891 mm

4

TOYOTA Carina, 4-dr Sedan, 96-00
TOYOTA Corona, 4-dr Sedan, 96-00

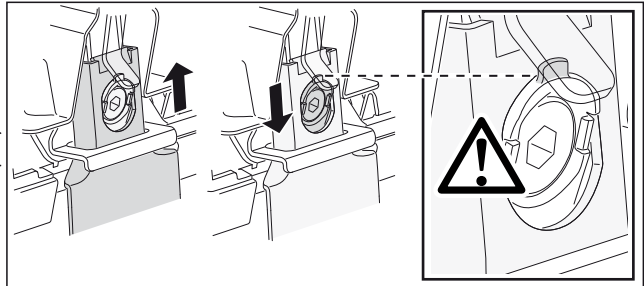
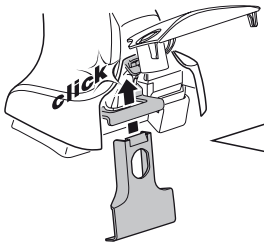
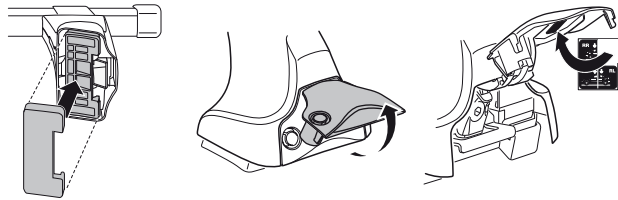
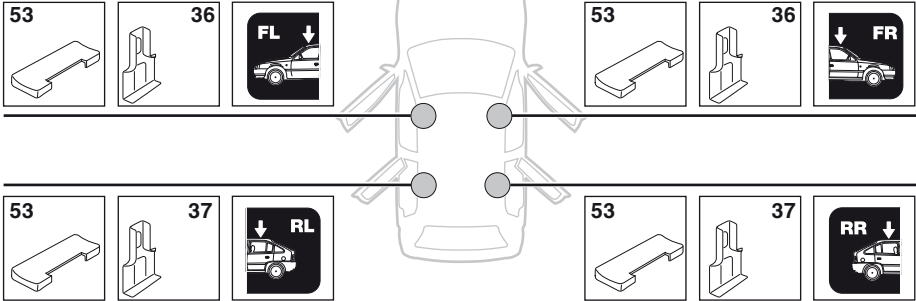

5



	X mm	Y mm	X inch	Y inch
TOYOTA Carina, 4-dr Sedan, 96-00	260 mm	710 mm	10 1/4"	28"
TOYOTA Corona, 4-dr Sedan, 96-00	260 mm	710 mm	10 1/4"	28"

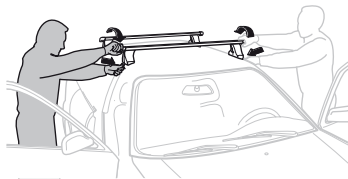
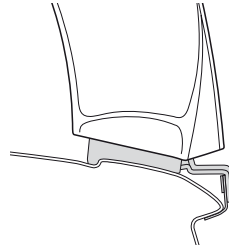
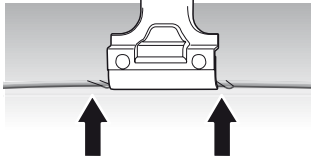
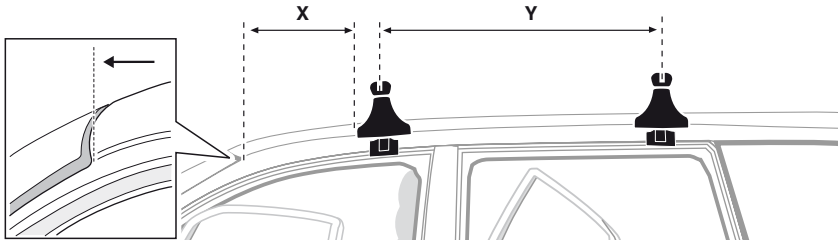

GB/US Tighten alternately

D Die Schrauben abwechselnd anziehen

F Serrer alternativement chaque côté

NL Afwisselend aan de linker- en de rechterkant aandraaien

I Alternare il serraggio delle viti

E Apretar alternativamente

PT Aperte alternadamente

S Dra åt växelvis

FIN Kierrä vuorotellen

EST Pinguldage vaheldumisi

LAT Pielvelciēt pamīšus

LIT Užsukinėkite pakaitomis

PL Śruby dokręcaj naprzemiennie

RU Затягивайте попеременно

CZ Pokręťta bagožníka dokręcaj dokręcaj naprzemiennie.

SK Doťahujte striedavo

SLO Privijajte izmenično.

HR Naizmjenično zategnite

HU Egymástól függetlenül szorítandó

GR Σφιγγετε εναλλάξ

TR Dönüşümlü sıkın

中文 交替拧紧

한국어 번갈아 가며 조이십시오.

日本語 交互に締め付けてください。

ไทย ชั้้นโน้บแบบสลับ

6



480R/754



480

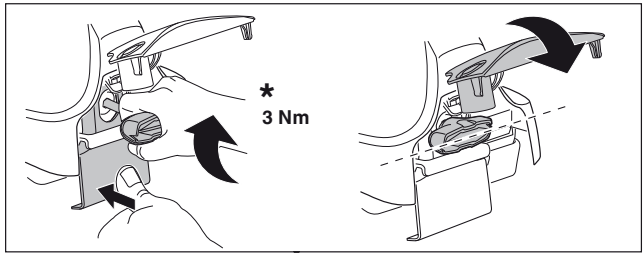
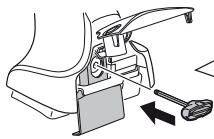

*
3 Nm

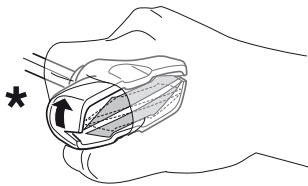

*

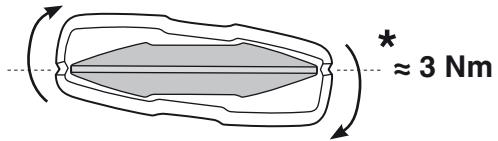

*
≈ 3 Nm

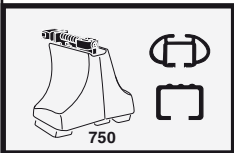
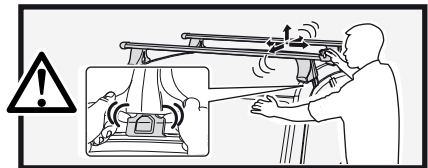

750

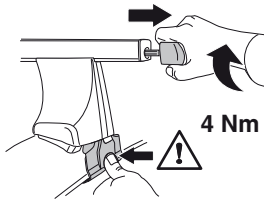

4 Nm

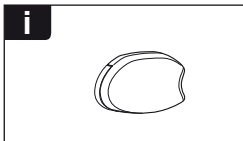
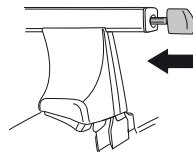

i

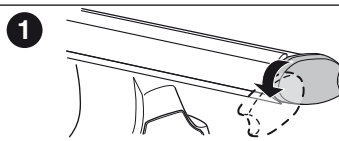

1

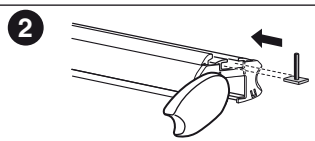

2

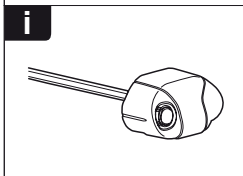

i

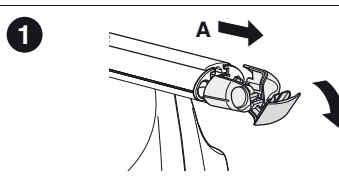

1

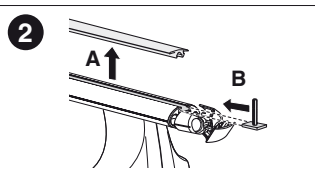

2

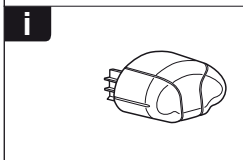

i

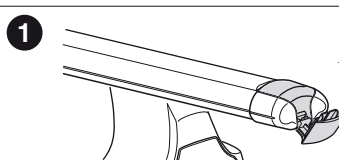

1

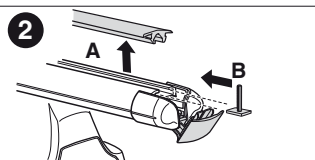

2

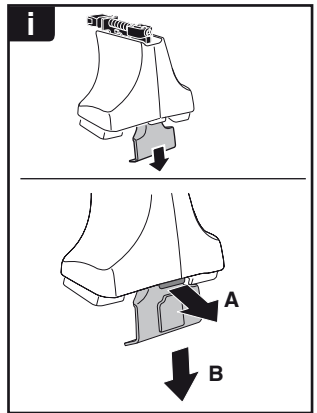
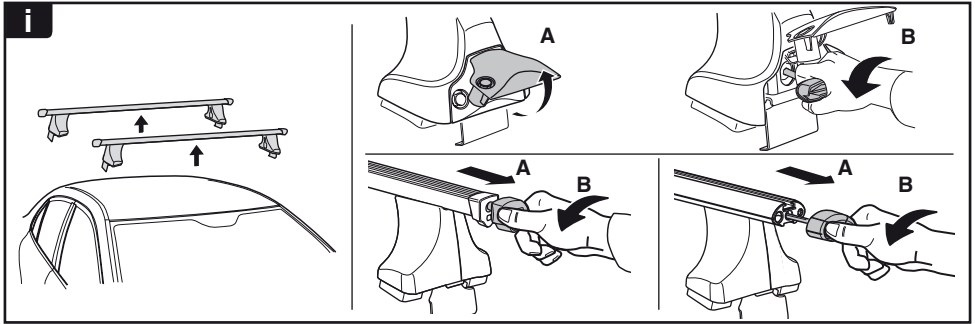

THULE
SWEDEN
**ONE
KEY
SYSTEM**



- 544 (x4)
- 596 (x6)
- 588 (x8)
- NA 510 (x10)
- EUR 452 (x12)
- ASIA



WW ▶ Thule Sweden AB, Box 69, 330 33 Hillerstorp, SWEDEN
 NA ▶ Thule Inc., 42 Silvermine Road, Seymour, Connecticut 06483, USA

info@thule.com
 customer.service@thule.com

www.thule.com