

Kit 1103

TOYOTA Prius, 4-dr Sedan, 98-03 / *01-03

*North America

480R
754

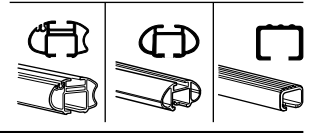
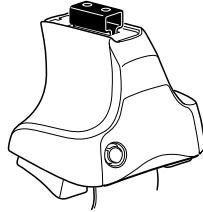

480

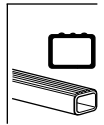
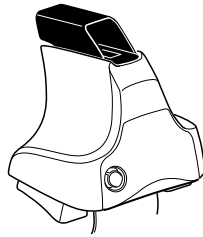

750

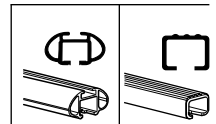
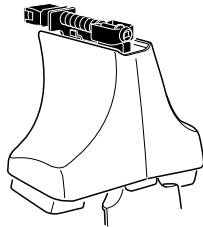

THULE[®]
SWEDEN

ISO 11154-E

Kit



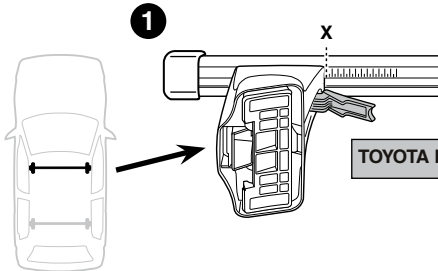

TOYOTA Prius, 4-dr Sedan, 98-03 / *01-03

X

40

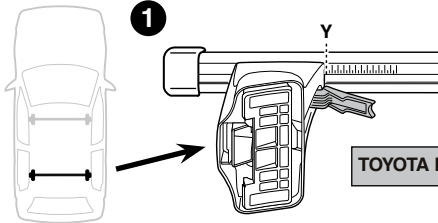

TOYOTA Prius, 4-dr Sedan, 98-03 / *01-03

Y

39

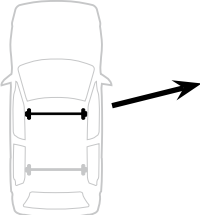
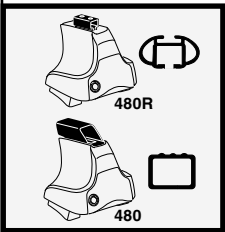

TOYOTA Prius, 4-dr Sedan, 98-03 / *01-03

X inch

41 3/8"

X mm

1051 mm

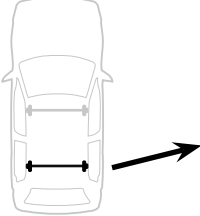

TOYOTA Prius, 4-dr Sedan, 98-03 / *01-03

Y inch

41"

Y mm

1041 mm

4

TOYOTA Prius, 4-dr Sedan, 98-03 / *01-03

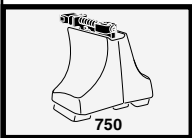
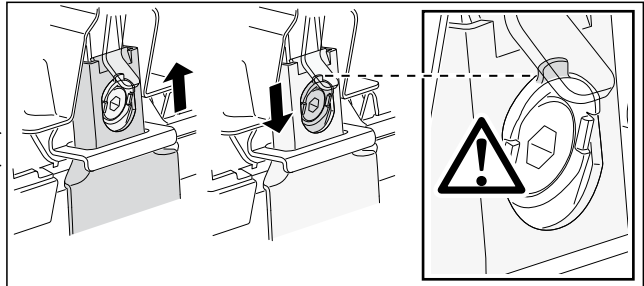
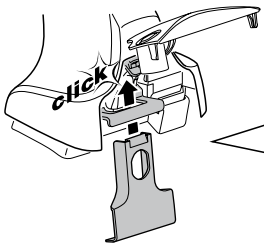
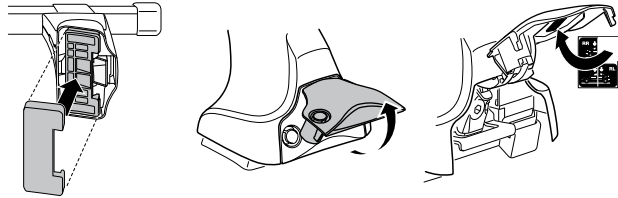
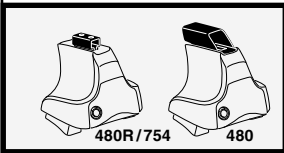
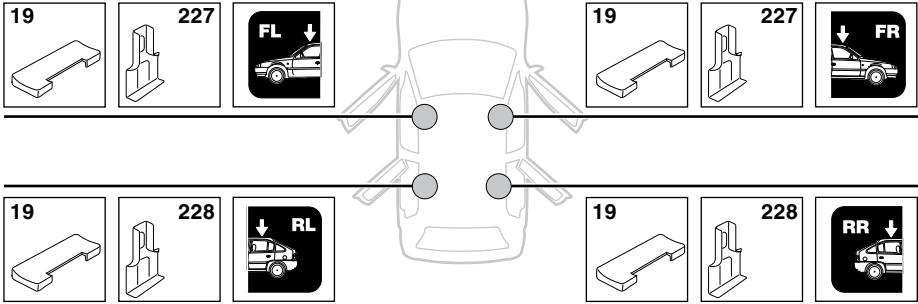

5



	X mm	Y mm	X inch	Y inch
TOYOTA Prius, 4-dr Sedan, 98-03 / *01-03	260 mm	700 mm	10 1/4"	27 1/2"

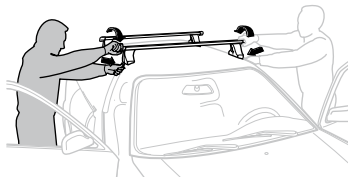
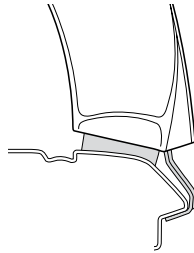
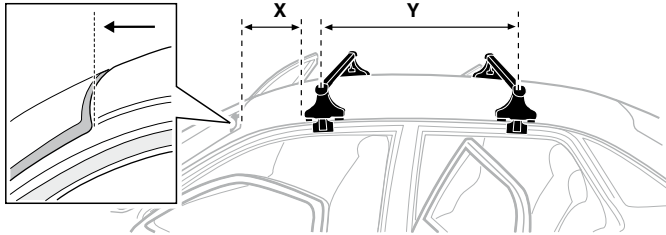

GB/US Tighten alternately

D Die Schrauben abwechselnd anziehen

F Serrer alternativement chaque côté

NL Afwisselend aan de linker- en de rechterkant aandraaien

I Alternare il serraggio delle viti

E Serrare alternativamente

PT Aperte alternadamente

S Dra åt växelvis

FIN Kierrä vuorotellen

EST Pinguldage vaheldumisi

LAT Pielieciet pamišus

LIT Užsukinėkite pakaitomis

PL Śruby dokręcaj naprzemiennie

RU Затягивайте попеременно

CZ Pokręťta багаžníka dokręcaj dokręcaj naprzemiennie.

SK Doťahujte striedavo

SLO Privijajte izmenično.

HR Naizmjenično zategnite

HU Egymástól függetlenül szorítandó

GR Σφιγγετε εναλλάξ

TR Dönüşümlü sıkın

中文 交替拧紧

한국어 번갈아 가며 조이십시오.

日本語 交互に締め付けてください。

ไทย ชันในแบบสลับ

6



480R/754



480



*
3 Nm



*



*
≈ 3 Nm

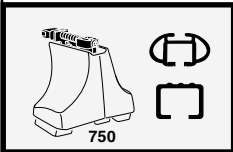
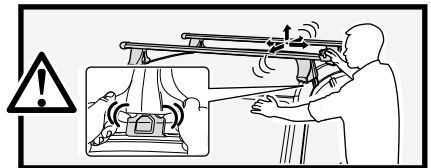

750

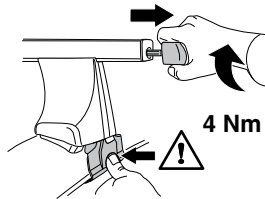

4 Nm

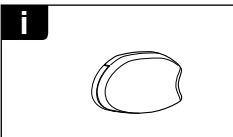
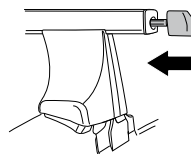

i

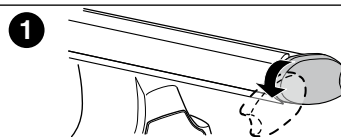

1

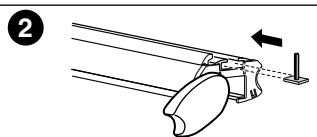

2

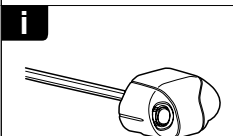

i

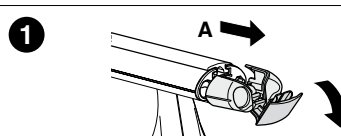

1

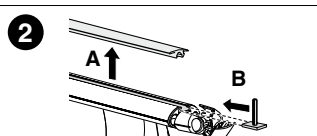

2

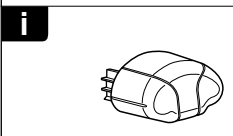

i

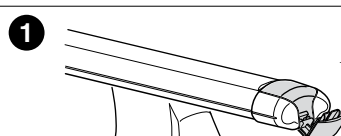

1

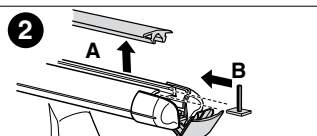

2

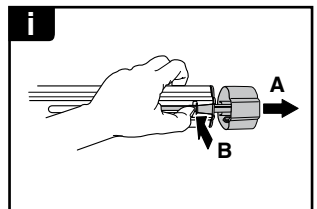
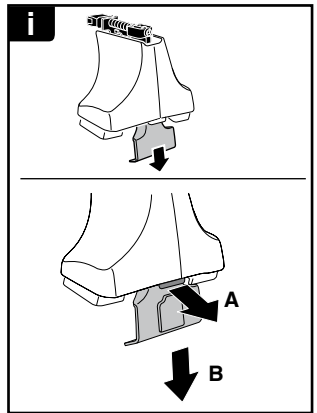
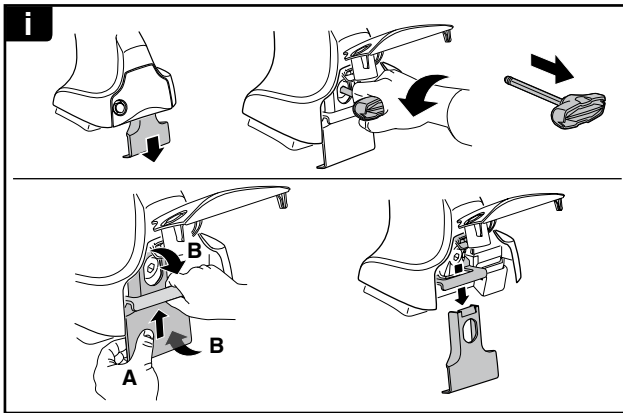
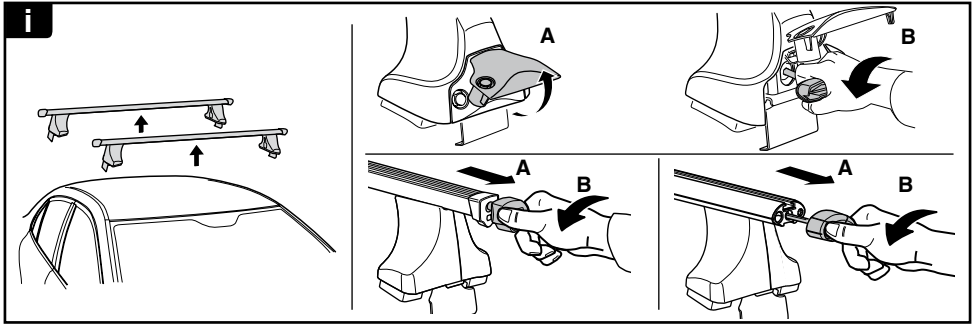

THULE
SWEDEN
**ONE
KEY
SYSTEM**

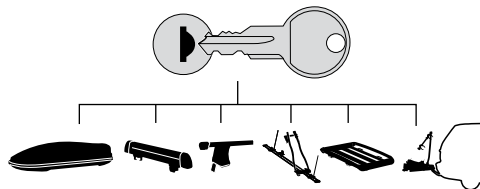

		(x4)
		(x6)
		(x8)
NA		(x10)
EUR		(x12)
ASIA		(x12)

